

SUSTAINABILITY REPORT FY20



logitech®

We want to make sustainability pervasive across all our activities and a reflection of our culture. We are reimagining how we source, manufacture, distribute and recycle, to positively improve the carbon, toxicity, circularity and social impact of our operations.

CONTENTS

INTRODUCTION

- 06 Statement from Bracken Darrell
- 08 FY20 Highlights
- 10 Company Structure
- 12 Logitech in Figures
- 14 Sustainability at Logitech
- 28 Stakeholder Engagement
- 32 Materiality Assessment

PRODUCTS & THE ENVIRONMENT

- 38 Statement from Prakash Arunkundrum
- 40 Design for Sustainability (DfS)
- 49 Responsible Packaging
- 53 Avoiding Targeted Substances
- 57 End-of-life Recycling
- 61 Responsible Manufacturing
- 65 Climate Action
- 74 Carbon Transparency

PEOPLE & SOCIETY

- 78 Ethics
- 82 Privacy and Security
- 84 Employee Safety, Health and Wellbeing
- 86 Conflict Minerals
- 89 Human Rights and Labor
- 95 Supplier Development
- 98 Statement from Kirsty Russell
- 100 Diversity and Inclusion
- 104 Talent Development
- 108 Giving Back

ABOUT THIS REPORT

- 116 About this Report
- 120 Data

INTRODUCTION



“

As a company, we believe positive change is necessary. Change for the environment. Change for inclusion. And an equal playing field for all. The world needs companies to stand up for environmental sustainability and diversity. And Logitech is.

Bracken Darrell
President and Chief
Executive Officer

”

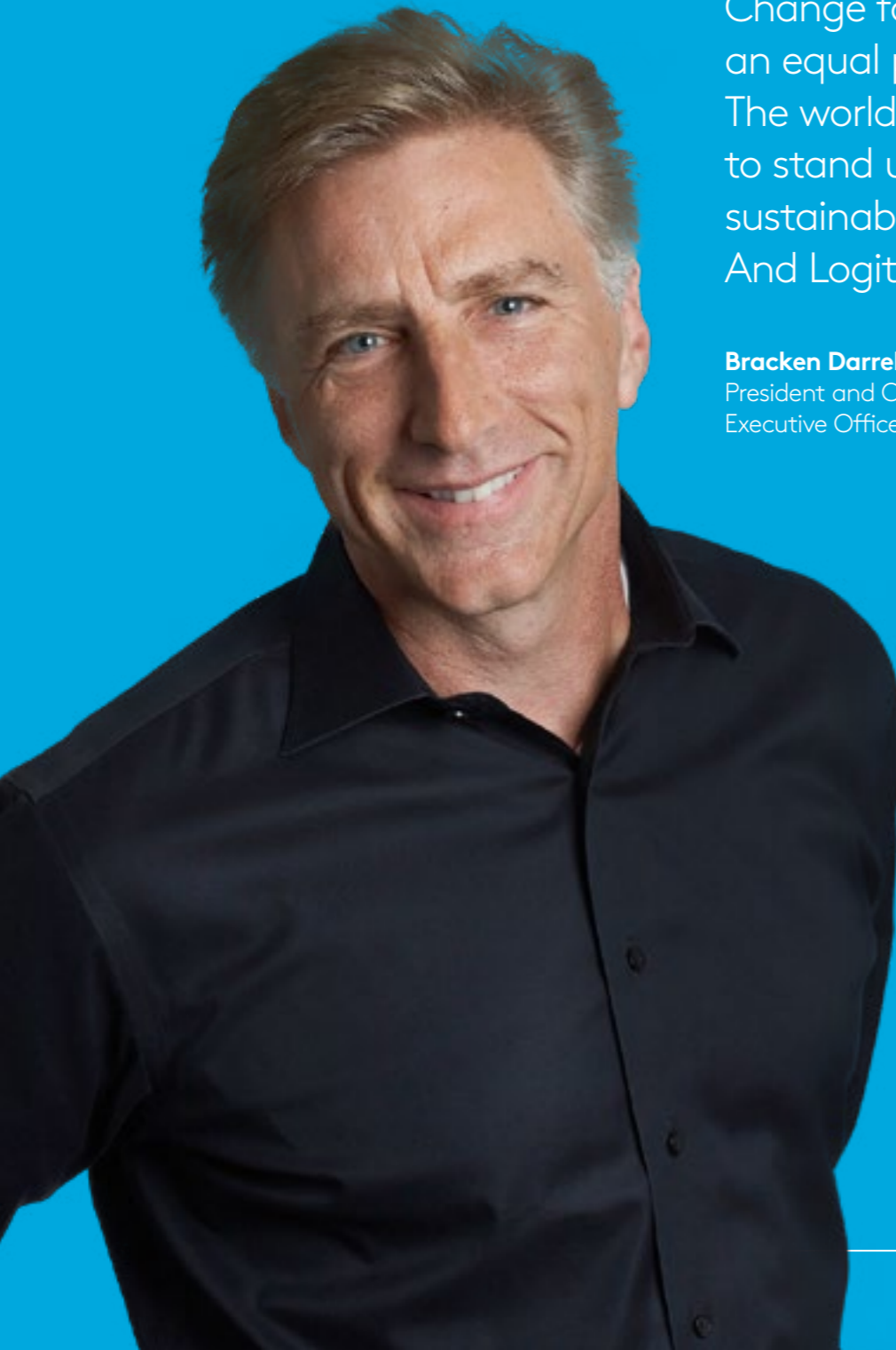

This is our twelfth sustainability report. Logitech’s culture has long reflected our Swiss roots: humble, hard-working and growth-minded. In fact, it took us over a decade of progress to decide we were ready to speak out beyond this report about our sustainability progress and ambitions. Before that, we quietly worked inside our factory walls and offices to reduce our impact on the environment.

About a year ago, we decided that quietly working hard on sustainability wasn’t enough. The world isn’t moving fast enough to address the environmental and societal challenges that we all face. As much as we’ve done and as far we’ve come, we at Logitech aren’t moving fast enough either.

So we decided to be more vocal. We stepped (a little timidly) into the public eye and made promises. Last year, we announced support of the Paris Agreement, pledging to reduce our corporate carbon footprint to support the ambitious goal of limiting global warming to 1.5 °C. We announced we will be powered exclusively by renewable electricity by 2030. And we let the world know we have neutralized the carbon footprint of our entire gaming product portfolio and will neutralize more of our business as we move ahead.

After being ranked fifth out of 145 tech companies for sustainability performance by Sustainalytics, we decided we would take further steps toward showing leadership in this area. We announced our carbon transparency commitment and became the first consumer electronics company to commit to providing carbon footprint labels on product packaging across our entire portfolio. Our vision is a world where everything is labeled with its carbon impact (or neutrality), like calories on food labels. We believe transparency in this area will drive competition to reduce product carbon footprints and will give consumers the information to make choices based on not just features and price, but also environmental impact. We called on companies in every industry to join with us, for only together can we realize the change that is desperately needed.

We recognize that our business growth does not come without an environmental impact. While we have made progress, we have only just begun to hit our stride in designing our products and our organization for sustainability.

Just as we are working toward a better planet, we are also working to do better for all

people. We foster diversity within Logitech but have much more to do to ensure we better represent the communities we serve. We are becoming an outspoken champion for inclusion outside our own walls through corporate giving, supplier diversity programs, accessible products, and much more to come. We commit to being transparent in our efforts and expect to be held accountable for significant improvement in the years ahead.

We are a company of committed believers that constant change is necessary. Change for the environment. Change for inclusion and equal playing field for all. While we want Logitech to be an inspiring company making a difference, we will remain a humble company always learning and growing.

Bracken Darrell
President and Chief
Executive Officer

SUSTAINABILITY

FY20 Highlights

CARBON TRANSPARENCY

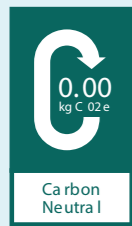

Corporate pledge to share and communicate the carbon impact of our products

CLIMATE ACTION



REDUCE

- Science-based reduction target for Scope 1 and 2
- 88% renewable electricity
- Scope 3 inventory disclosed



RENEW

- 3rd-Party-certified carbon calculator for distribution activities



RESTORE

- Carbon Neutral Production Facility and Travel
- Gaming products CarbonNeutral ©

TARGETED SUBSTANCE REDUCTION



73%
reduction in Targeted Substances since CY10

131t
of PVC eliminated in CY19

DESIGN FOR SUSTAINABILITY (DfS)



Design process updated to include environmental performance as a core design goal



Sustainable Design Principles established as a framework for product development



New calculator tools to rapidly assess carbon and circularity during concept development



Roadmap for future low impact product materials

POST-CONSUMER RECYCLED (PCR) PLASTIC:



3 additional product lines transitioned to PCR

RESPONSIBLE PACKAGING:



- Logitech sustainable packaging design guidelines established and socialized.
- 3 additional product lines launched with FSC-certified packaging

GLOBAL RECYCLING

tons financed since CY10

30,992

electrical devices



2,797

batteries



16,993

packaging



CONFLICT MINERALS



98%

of smelters certified conflict-free

100%

- Direct suppliers engaged
- Conflict-free tantalum
- Conflict-free tungsten

Ta	73	Sn	50
W	74	Au	79

AWARDS & ACKNOWLEDGEMENTS



- World Finance Leadership Award for Sustainability in the Technology Sector
- FTSE4Good index listed
- Ecovadis gold rated
- Sustainalytics 96th Percentile Leader

SUPPLIER DEVELOPMENT

RBA Code of Conduct



100%

of our major suppliers audited in CY19

TALENT DEVELOPMENT



12,000+

employees training hours worldwide

GIVING BACK



23

Give back events with 400+ volunteers in 13 cities and 9 countries

COMPANY STRUCTURE

Logitech is a world leader in designing, manufacturing and marketing products that help connect people to digital and cloud experiences.

Almost 40 years ago, Logitech created products to improve experiences around the personal computer (PC) platform. Today we are a multi-brand, multi-category company. We design products that enable better experiences consuming, sharing and creating any digital content, including computing, gaming, video and music, whether it is on a computer, mobile device or in the cloud.

Logitech was founded in Switzerland in 1981. Our registered office and holding company (Logitech International S.A.) is in Apples, Switzerland. Logitech Inc. is our principal, wholly-owned subsidiary in the United States.

Our global footprint extends across North and South America, EMEA (Europe, the Middle East and Africa) and Asia Pacific. We employ more than 6,600 people, including more than 3,000 at our production facility. Our network of offices includes 24 Principal Offices (i.e. offices with more than 20 occupants) and a number of smaller (sales-focused) offices worldwide.

Shares of Logitech International S.A. are listed on the SIX Swiss Exchange (trading symbol: LOGN) and on the Nasdaq Global Select Market (trading symbol: LOGI).

As of March 3, 1 2020, our total capitalization was \$1,489 million USD, funded 100% by equity, with zero debt. Total net sales for FY20 were \$2.98 billion.

From our humble beginnings as a Swiss hardware company, we now create products across the following five large market opportunities.

The Logitech family currently comprises seven master brands: Logitech, Logitech G, ASTRO Gaming, Streamlabs, Blue Microphones, Jaybird, and Ultimate Ears.

Creativity and Productivity

With ever-increasing connectivity and consistent growth in time spent by people on computing platforms, we continue to innovate and grow market share for pointing devices, keyboards/combos, tablets and other accessories and webcams.

We sell our products to a broad network of domestic and international customers, including direct sales to retailers and e-tailers, and indirect sales via a network for third-party distributors. Our worldwide channel network includes consumer electronics distributors, retailers, mass merchandisers, electronics stores, computer and

telecommunications stores, value-added resellers and online merchants.

Gaming

Our Gaming category comprises PC and console products designed to enhance gamer experiences, including virtual and augmented reality. We design and engineer industry-leading keyboards, mice, headsets, mouse pads, controllers and simulation products such as steering wheels and flight sticks.

Video Collaboration

Our Video Collaboration category includes Conference cams that combine enterprise-quality audio, high definition (HD), 1080p video and affordability, to enable video conferencing by businesses of any size.

1981

LOGITECH FOUNDED
IN SWITZERLAND

6,600+

EMPLOYEES

logitech®



astro

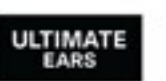

Music

Our Music category includes two sub-categories:

- Mobile Speakers; and
- Audio & Wearables.

The Mobile Speakers sub-category includes portable wireless Bluetooth® and Wi-Fi speakers that are waterproof and provide bold, immersive sound in every direction.

The Audio & Wearables category comprises:

- PC speakers and headsets;
- in-ear headphones;
- premium wireless audio wearables;
- wireless audio wearables for sports and active lifestyles; and
- a range of audio tools for recording or broadcasting applications, from YouTube and podcast production to music and gaming.

Smart Home

This category includes advanced home entertainment controllers and home cameras that enable home monitoring via mobile devices. It also includes new products dedicated to controlling emerging categories of connected smart home devices such as lighting, thermostats and door locks.

Acquisitions

On August 21, 2018, we acquired all equity interests in Blue Microphones Holding Corporation (Blue Microphones). While we report financial information with full integration of Blue Microphones from that date, from an operational standpoint (including sustainability procedures) we completed integration of Blue Microphones on September 2, 2019. The scope of this Sustainability Report includes data and performance for Blue Microphones from September 2019 onwards.

On October 31 2019, we acquired all equity interests in General Workings, Inc. (Streamlabs). Streamlabs is a leading provider of software and tools for professional streamers. The Streamlabs Acquisition is complementary to our gaming portfolio.

The scope of this Sustainability Report does not include data and performance associated with this acquisition, because the Logitech-Streamlabs integration process was ongoing within the reporting period.

Joint Ventures

We do not operate Joint Ventures.

Production Facility

Our high-volume production facility was established in Suzhou, China in 1994. On-site activities primarily comprise final assembly and testing. Components are manufactured to our specification by suppliers in Asia, the United States and Europe.

We use Joint Design Manufacturers and Contract Manufacturers to supplement internal capacity and to reduce volatility in production volumes. Our local and international teams maintain oversight of all in-house and supplier production activities, manufacturing know-how, quality process controls, social and environmental responsibilities and Intellectual Property protection.

This hybrid model of in-house manufacturing and third-party manufacturers enables us to effectively respond to rapidly changing demand, leverage economies of scale, maintain strong quality process controls, reduce volatility in production levels, and optimize time to market.

An overview of our company is shown in the following infographic.

LOGITECH IN FIGURES

FY20

27%
FEMALE BOARD OF DIRECTORS

6,600+
EMPLOYEES

65%
MALE

35%
FEMALE

>\$177m+
SPEND ON R&D

54
DESIGN AWARDS

\$2.98 BILLION
NET SALES (FY20)
(%) BY PRODUCT CATEGORY

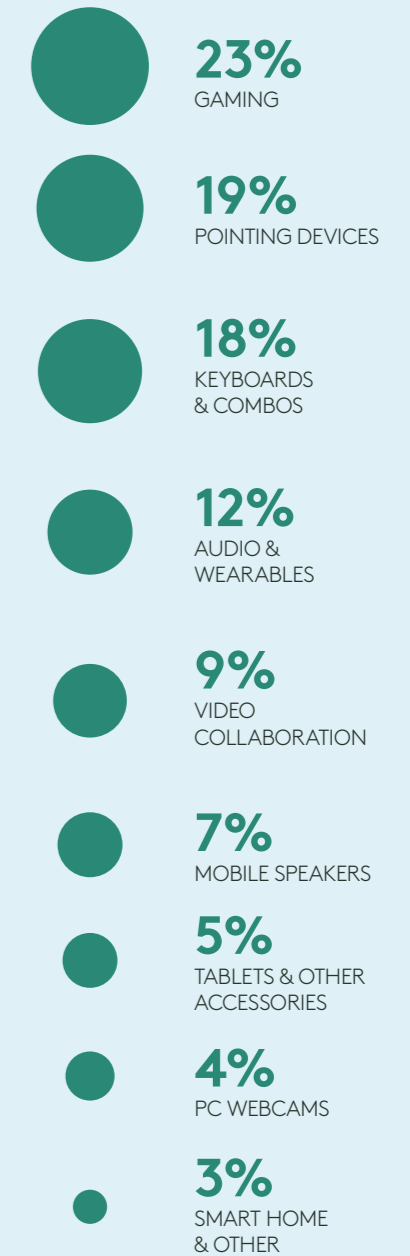

SUSTAINABILITY AT LOGITECH

As a company, we always strive to do the right thing, behave ethically and act with integrity; we live and breathe our values. That philosophy underpins our commitment to sustainability.

Our vision is to design new possibilities that extend human capability. As a company, we're fully conscious of the connections we can make between people, products, society and the environment. We want to design experiences, which help people create, achieve and enjoy life more.

As a company, we're small and flexible enough for every person to take the initiative and make things happen. But we're big enough in our portfolio and reach for those actions to have a global impact. That's a unique position to be in and we will always try to keep it that way.

We are acutely aware of the impact our activities can have, on our planet and society. That awareness motivates us to quantify, advocate, lead and drive the changes that are needed, to transition to a more sustainable world. We are working to make sustainability pervasive across all our activities and a reflection of our culture.

Values and Culture

As a global company our people bring an array of diverse perspectives and unique experiences needed to

innovate, understand different markets and pull together across the globe to make things happen locally and build competitive advantage.

Our values and culture were articulated as an outcome of interactive roadshows in 2016, which were initiated by our Chief Executive Officer and Head of People and Culture. More than 85% of our employee base contributed their insights on four key aspects of our company culture: the most important elements of Logitech's culture, as identified by employees; the words and sentiments employees use when describing Logitech culture to others; which elements are aspirational and require us to keep working on them; and what we need to inject more of, to keep us successful in the future. The values were articulated in English and translated into local languages by site leaders, where appropriate.

Our values are included in onboarding and orientation and underpin our employee recognition and awards program, our talent and development programs and other initiatives. Site leaders regularly organize events,

teamwork and news based on the value sets, to raise awareness and socialize our values to new and existing employees.

We are the sweet spot for people passionate about products, making a mark and having fun. We believe we are at our best when we:

- prioritize equality and environment;
- are open and ourselves;
- are humble but hungry;
- collaborate, but also challenge; and
- decide and do.

This year, we introduced a new pair of values: Equality and Environment. Our commitment to equality and the environment is something that has been an integral part of our culture and demonstrated through our actions and commitments. We explicitly recognize equality and environment as core values of our company, for greater alignment and accountability internally and to demonstrate leadership and raise stakeholder awareness externally.

EQUALITY AND ENVIRONMENT

We believe every individual should have equal access to opportunity. Within Logitech, we work to offer equitable opportunities for each individual, regardless of gender, race, religion, sexual orientation, and more.

Externally we stand up for the rights of under-represented groups

especially in the face of adversity and will challenge systemic barriers. By doing this, we hope to level the playing field for everyone.

We strive to be responsible for our planet and advocate for sustainability.

OPEN AND OURSELVES

We want everyone to feel they can be themselves in every way, no pretense, no dress code, nor other limitations.

We treat each other fairly and respectfully - and when mistakes are made they can be openly discussed. We're also not interested

in politics, just in doing what's right ethically and acting with integrity. That also means that if there's something wrong, speaking up in the moment is something we feel obliged to do. It's just less stressful when what you see is what you get.

HUNGRY BUT HUMBLE

Humility is something we associate with the quest to always learn. We continuously learn, from all experiences including those that

could be characterized as wins and losses, successes and failures. Our hunger to do more, better, faster makes us hard to compete with.

COLLABORATE, BUT ALSO CHALLENGE

We achieve more when we work together. It's that simple. It's always nice when someone agrees but we constantly seek challengers to our ideas. Working collaboratively with colleagues, customers and partners surfaces possibilities that one person alone might not see.

We also need to collaborate on something bigger than our own interest - which means that sometimes we might feel like we're losing something but someone else is gaining. And that's just fine as long as the gain is a gain for the wider Logitech.

DECIDE AND DO

We are a company of people who decide based on data/facts/good thinking and communicate the how and why to key stakeholders. We turn decisions into action. We don't philosophize or pontificate. We believe no-one in Logitech is a pure

'boss' or 'executive'. We spurn jobs that aren't hands-on because they are suggestive of those people who tell other people to do things, rather than engaging alongside them in the sometimes messy and granular work of getting things done.



Sustainability at Logitech

continued

Sustainability at Logitech

We are often asked what we mean by sustainability at Logitech. Sustainability can mean different things to different people depending on your priorities, experience and perspective. Within Logitech, the terms SER (Social, Environmental, Responsibility) and ESG (Environment, Social and Governance) are synonymous with Sustainability. SER is the term used by the RBA. ESG is the term used by our investors. Our sustainability programs, as described in this report, address all material aspects of sustainability, SER and ESG.

We explain our approach in the following terms.

We have **footprint** activities and programs which seek to reduce our environmental impact on the planet:

- Climate action
- Carbon transparency
- Responsible manufacturing
- Design for sustainability (DfS):
 - Responsible products
 - Responsible sourcing
 - Responsible packaging
- End-of-life recycling

For these programs we measure our impact in terms of carbon, toxicity and circularity improvements primarily, as well as additional dimensions, such as water, where appropriate.

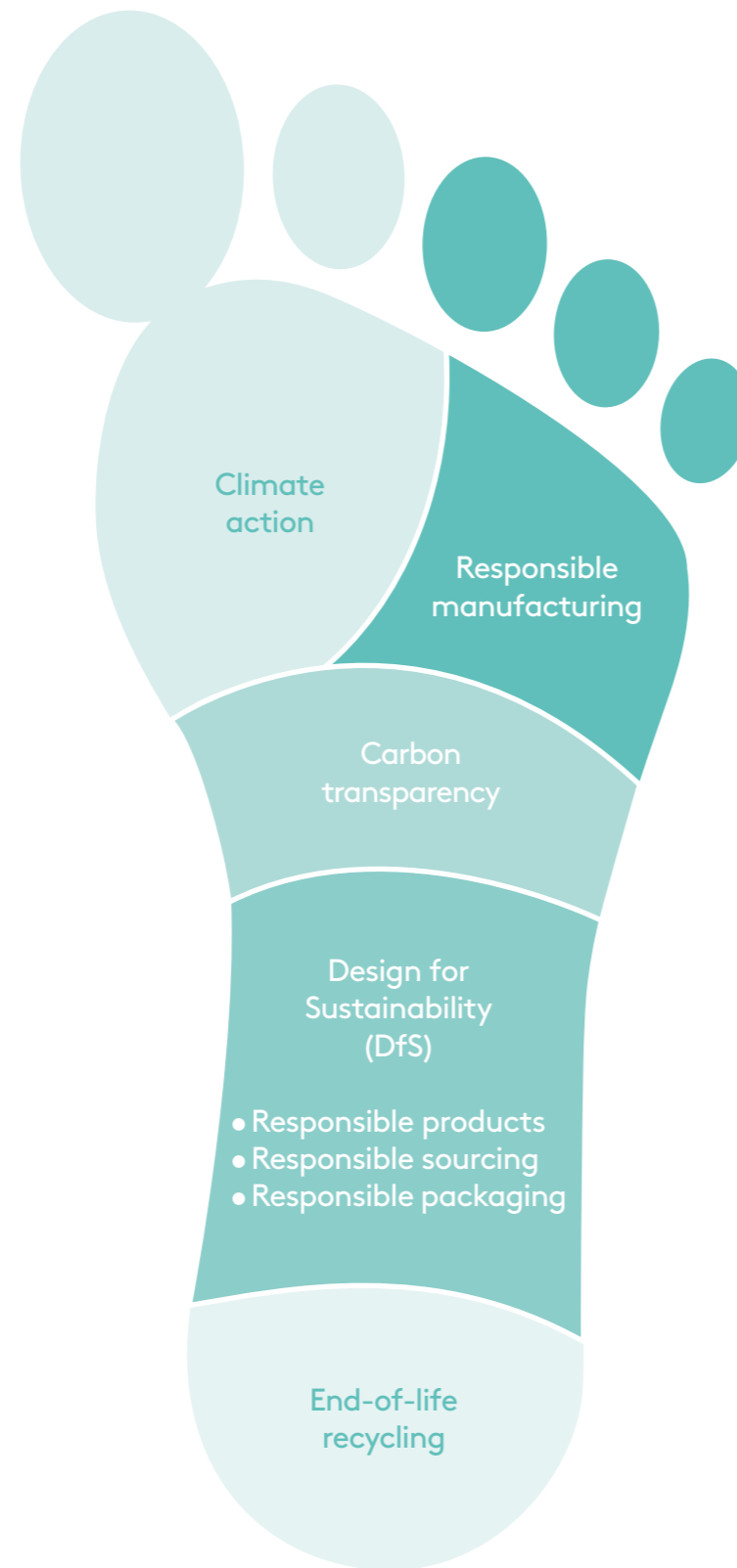

We have **handprint** activities and programs which seek to enhance our positive impact on people and society:

- Human rights and labor
- Ethics
- Privacy and Security
- Conflict minerals
- Supplier development
- Talent development
- Diversity and inclusion
- Safety, health and wellbeing
- Giving back

Some of our management programs are cross-cutting, creating value in terms of a reduced environmental footprint and enhanced positive handprint on people and society e.g. our Supplier Development program and Sustainability Reporting program. But our use of the handprint and footprint concept has helped us simplify communication of our approach and performance. We like it. We hope you do too.



Sustainability at Logitech

continued

Sustainability Governance

Good governance is driven by strong, effective and committed leadership. Our Group Management Team and Board of Directors can be viewed on our website [here](#). Our governance structure for strategic decision-making is our Sustainability Office. Prakash Arunkundrum (Head of Global Operations and a member of the Group Management Team), leads the Sustainability Office and is responsible for driving the strategy and execution of Logitech's sustainability initiatives and advancing Logitech's sustainability commitments across its worldwide operations and products.

The Sustainability Office is a standing arrangement that addresses and prioritizes sustainability-related decisions as they arise. The Sustainability Office formally meets monthly to review progress on existing commitments and assesses sustainability risks and proposals from across the business in relation to our sustainability priorities. The structure offers decision and guidance at an operational and management level, as well as wider recommendations to the Board of Directors and other relevant executive committees at a strategic level, on an annual

basis. The office also oversees the preparation of key reports and data, including the annual Sustainability Report, and manages climate and carbon-related risks and opportunities.

Governance Framework

Our framework for sustainability management is the RBA Code of Conduct ("the Code") and our 1.5 Degree Pledge.

As a small company playing in a global market, we recognize the value of collaboration. We joined the Responsible Business Alliance (RBA, formally known as the Electronics Industry Citizenship Coalition, EICC) in 2007 to collaborate with industry peers and competitors alike, to develop and implement tools and programs that would directly address the challenges that people, communities and the environment face around our industry. RBA members are held accountable to the [RBA Code of Conduct](#). We implement the Code at our own production facility and in our supply chain, using a range of RBA training and assessment and support tools.

Our commitment to the Code is defined in our [RBA Commitment Statement](#). The Code focuses on priority issues for the RBA membership (as

As a company, we want to leave our mark. Our commitment to shaping a better world is a core value that we care deeply about.

Governance Framework

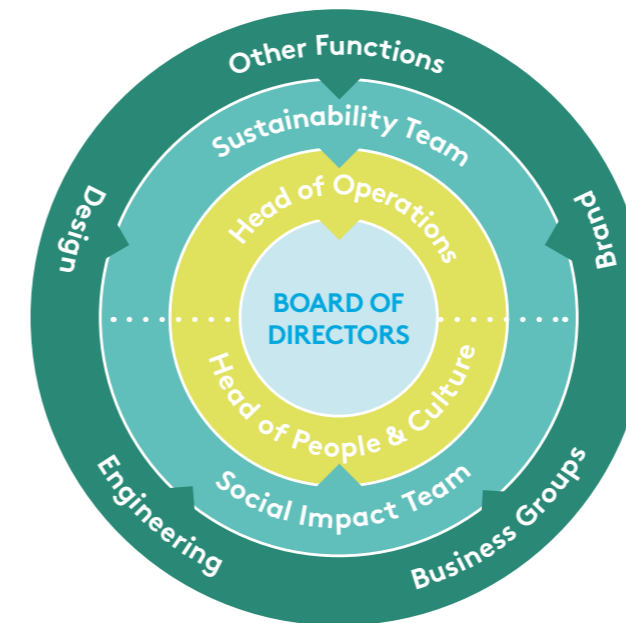

Leadership COMMITMENT & SPONSORSHIP

Head of Operations and Head of People and Culture identify, finance & sponsor selected programs, liaising with the Board, where relevant.

Sustainability Office IMPACT ASSESSMENT

Sustainability Office review, assess and shortlist proposed programs for consideration within framework of Logitech's Sustainability Priorities.

All teams SUSTAINABILITY PROPOSALS

Sustainability programs, projects and specific opportunities are brought to the Sustainability Office to assess impact, priority and relevance.

shown in the figure on p.22), including emerging issues that are not well understood. It is reflective of international norms and good practice, including the Universal Declaration of Human Rights, ILO International Labour Standards, OECD Guidelines for Multinational Enterprises, OHSAS 18001, ISO 14001 and SA8000.

RBA engages stakeholders from across business, governments, civil society, investors and academia to gather the necessary range of perspectives and expertise to review and

update the Code year-on-year. This forward-thinking approach helps us apply the precautionary principle, look beyond our legal obligations, deliver on our commitment to continually improve our performance, and ensure we live and breathe our company values. The Code is reflected in our internal policy framework, standards, audit processes and contractual agreements with suppliers. It drives our business and sustainability strategy and informs decision-making.

At Logitech, sustainability is not a buzzword or an afterthought. It's a mindful principle that we infuse into everything we do.



Responsible Business Alliance

Formerly the Electronic Industry Citizenship Coalition

Advancing Sustainability Globally



[Company Commitment](#)

[Management Accountability and Responsibility](#)

[Legal and Customer Requirements](#)

[Risk Assessment and Risk Management](#)

[Improvement Objectives](#)

[Training](#)

[Communication](#)

[Worker Feedback, Participation and Grievance](#)

[Audits and Assessments](#)

[Corrective Action Process](#)

[Documentation and Records](#)

[Supplier Responsibility](#)

Sustainability at Logitech

continued

In December 2019, we joined the Science-Based Targets Initiative (SBTI) and committed to support the Paris Agreement and develop science-based carbon reduction targets to deliver our ambitious 1.5°C climate pledge.

Climate change caused by human activity is one of the biggest challenges of our generation. With our commitment to the 1.5°C climate pledge, we stepped beyond both legislative and RBA Code requirements to take on a leadership position around this challenge. Our 1.5 degree pledge is driving us to quantify our environmental impact in terms of our corporate carbon footprint and apply a design-thinking approach to reduce our footprint; use renewable electricity and materials; and restore climate-impacted communities.

Design thinking is at the center of everything we do. We believe the design-thinking approach can be applied to everything, including sustainability. As an award-winning design company, we are making a pledge to future generations, to use our leadership in design to create great customer experiences, but to do so in a way that is sustainable for the planet and good for society. When we look at our business, products and activities through this lens, we know we can design processes and product experiences for

sustainability, and improve every aspect of our operations. When we couple this way of thinking, with our engine for innovation and commitment to carbon transparency, we believe we can make a meaningful contribution to global efforts to enable more sustainable lifestyles and catalyze our sector's transition to a more sustainable, low carbon pathway. We are working to map our handprint and footprint to the Sustainable Development Goals, to identify the areas where we can make the greatest contribution to development issues.

External Initiatives and Memberships

We believe collaboration across our sector and multi-stakeholder engagement is required, to catalyze society's transition to a more sustainable future. In recent years we have taken a more overt approach to demonstrating our commitment to Sustainability. In doing so, we decided to be more vocal. Since then, we have strengthened our existing involvement in external initiatives and membership associations and adopted a number of new membership initiatives and reporting standards. A full description of the initiatives and associations we currently participate in, and some of our key reporting standards, is provided overleaf.

Design at Logitech is a 360-degree process, beyond the look and feel of a product. From your day in the office, to a run on the trail, to how you enjoy your favorite games and music, great design is much more than the sum of a product's parts; it is about how each experience fits in our lives and adds something new and valuable.

Alastair Curtis, Chief Design Officer at Logitech

Sustainability at Logitech

continued

REPORTING STANDARDS AND SUSTAINABILITY PARTNERSHIPS	WHAT THIS PARTNERSHIP MEANS FOR US
 <p>The Carbon Disclosure Project (CDP) is an international organization providing a global, standardized system for companies to disclose and share carbon, energy and environmental information</p>	<p>We leverage the CDP platform to report our energy and climate performance publicly, via the Climate Change questionnaire and to respond to customers via the CDP Supply Chain questionnaire.</p> <p>By sharing our performance in this best practice way, we work to galvanize sector-wide transparency and credibility.</p>
 <p>The Global Reporting Initiative (GRI) is a nonprofit organization that promotes one of the world's most prevalent standards for sustainability reporting - the GRI Standards</p>	<p>We are committed to, and working towards, full alignment with Core GRI standards to enable enhanced transparency, credibility and accountability in reporting.</p>
 <p>The Information Technology Industry (ITI) Council is an advocacy and policy organization for the technology sector. Through its regional and topic-specific committees, ITI provides members with information, insights and diverse perspectives on developing policy frameworks and regulatory changes around the world.</p>	<p>We participate in ITI's regional committees as well as topic-specific committees on Environmental Policy, Environment and Sustainability, Privacy and Cybersecurity, Energy Efficiency, Procurement, Product Stewardship and Regulatory Policy.</p>
 <p>The National Minority Supplier Development Council (NMSDC) matches certified minority-owned business enterprises (MBE) in the United States with corporate member companies and builds MBE capacity and capabilities through programs and other educational offerings.</p>	<p>Through our membership of the NMSDC, we are working to develop our Supplier Diversity Program and connect with MBEs across the US, to diversify our supplier base.</p>
 <p>The Organisation for Economic Co-operation and Development (OECD) is an international economic body of 37 countries dedicated to stimulating economic progress and world trade.</p> <p>The OECD Due Diligence Guidance for Responsible Supply Chains of Minerals from Conflict-Affected and High-Risk Areas sets out best practice guidance for companies to respect human rights and avoid contributing to conflict through their mineral purchasing decisions and practices.</p>	<p>We follow the OECD due diligence guidelines for supply chain due diligence specifically around minerals from conflict-affected and high risk-areas.</p>
 <p>The Responsible Business Alliance (RBA), formerly EICC, is a non-profit coalition of companies committed to improving social, environmental and ethical conditions in their global supply chain.</p> <p>The RBA Code focuses on priority issues for the RBA membership including labor, environment, health and safety, ethics, management systems and human rights.</p>	<p>We joined the RBA in 2007 and our commitment to the RBA Code drives our business, sustainability and supply chain strategy. It informs decision-making and is reflected in our internal policy framework, standards, audit processes, and contractual agreements with suppliers.</p>

REPORTING STANDARDS AND SUSTAINABILITY PARTNERSHIPS	WHAT THIS PARTNERSHIP MEANS FOR US
 <p>The Responsible Minerals Initiative (RMI) is an industry initiative focused on responsible mineral supply chain of conformant smelters and refiners for tin, tungsten, tantalum and gold. The RMI developed the Responsible Minerals Assurance Process (RMAP) which includes tools for members to use and leverages independent, third-party audit processes to identify conflict-free smelters and refiners.</p>	<p>Through our membership of the RMI, we gain access to tools and resources for our Conflict Minerals due diligence program, including the Conflict Minerals Reporting Template, Reasonable Country of Origin Inquiry data, and a range of guidance documents supporting responsible minerals sourcing.</p>
 <p>The Responsible Labor Initiative (RLI) is a multi-stakeholder initiative launched by the RBA which is focused on ensuring that the rights of workers vulnerable to forced labor in global supply chains are consistently respected and promoted.</p>	<p>Through our membership of the RLI, we gain access to tools and resources which support our Supplier Development due diligence programs including the Supplemental Validated Audit Process (SVAP) on Forced Labor.</p>
 <p>RE100 is led by The Climate Group in partnership with CDP. RE100's mission is to accelerate a global shift to clean energy and zero carbon grids - delivering a cleaner, healthier future for all. RE100 members work together to advocate for 100% renewable electricity worldwide, in the shortest timeline possible, and work in partnership with others to address policy and market challenges</p>	<p>We joined the RE100 initiative in November 2019 to collaborate with other industry leaders in pursuit of the global movement to catalyze uptake of 100% renewable electricity.</p>
 <p>The mission of the Sustainability Accounting Standards Board (SASB) Foundation is to establish and improve industry-specific disclosure standards across financially material environmental, social and governance topics that facilitate communication between companies and investors about decision-useful information.</p>	<p>We are working towards full alignment with SASB standards to enable transparency, credibility and accountability in reporting - for our US investors, in particular</p>
 <p>The Science Based Targets Initiative (SBTI) is a partnership between CDP, the United Nations Global Compact (UNGC), World Resources Institute (WRI) and the World Wide Fund for Nature (WWF). SBTI defines and promotes best practice in science-based target setting with the support of a Technical Advisory Group. Signatories are required to set ambitious and meaningful carbon reduction targets, which are independently assessed to verify alignment with the newest science and recommendations from the Intergovernmental Panel on Climate Change (IPCC)</p>	<p>By joining SBTI, we commit to a science-based approach to climate action and ambitious, best-practice reduction targets for our Scope 1, 2 and 3 emissions. In our specific case, we have committed to the ambitious 1.5 degree pathway.</p>

Sustainability at Logitech

continued

REPORTING STANDARDS AND SUSTAINABILITY PARTNERSHIPS	WHAT THIS PARTNERSHIP MEANS FOR US
 <p>The United Nations Sustainable Development Goals (SDGs) are a call to action for bold breakthroughs across 17 development areas, by the year 2030. The aim of the SDGs is to push multi-stakeholder collaboration to improve quality of life, protect the environment, and foster equitable growth.</p>	<p>Following on from our commitment to the SDGs last year we are working to map our handprint and footprint programs to the SDGs to identify the areas where we can make the greatest contribution to development issues</p>
 <p>The aim of the Task Force on Climate-related Financial Disclosures (TCFD) is to develop voluntary, consistent climate-related financial risk disclosures for use by companies in providing information to investors, lenders, insurers, and other stakeholders.</p> <p>The Task Force will consider the physical, liability and transition risks associated with climate change and what constitutes effective financial disclosures across industries.</p>	<p>We are working towards full alignment with TCFD guidance, with the disclosure of relevant information in our annual CDP Report and Sustainability Report.</p>
 <p>WeConnect International is a global network that connects women-owned businesses to qualified buyers around the world.</p>	<p>Through our membership of WeConnect, we are working to develop our Supplier Diversity Program and connect with women-owned businesses across the globe to diversify our supplier base.</p>
 <p>The Women's Business Enterprise National Council (WBENC) is the largest certifier of women-owned businesses in the US and a leading advocate for women business owners and entrepreneurs.</p>	<p>Through our membership of WBENC, we are working to develop our Supplier Diversity Program and connect with women-owned businesses across the US to diversify our supplier base.</p>

Evaluation of the management approach

We employ a number of mechanisms to evaluate our management approach.

- Via the **Sustainability Office**, as described above, we routinely review the purpose, scope and value

of sustainability proposals and how they align with our overall commitments and potential to deliver our vision for a better future, as well as the effectiveness of our management approach and our allocation of resources to priority goals and targets.

- With our **External Factors Review** (EFR) process, we review publicly available sources of information - to evaluate external perspectives of our management approach and sustainability performance and identify new or emerging expectations for our sector or our own organization,

as well as opportunities for long-term reputational value or reputational risks. Insights from the EFR process inform decision-making with respect to our management approach, including our stakeholder engagement strategy, sustainability reporting, and sustainability strategy.

- At our production facility, we participate in **third-party audits**, which evaluate our management approach and performance in relation to RBA Code requirements, as well as ISO14001 Audits, OHSAS

18001 and ISO9001 standards. As part of these audits, third-party auditors evaluate our management approach and performance in relation to RBA Code compliance topics, environmental best practice and health, safety and quality.

- As part of **annual Sustainability Reporting**, we review the scope and performance of our footprint and handprint programs, evaluate performance to determine how best to evolve each program for the forthcoming year. We

also review and refresh our policy framework to identify opportunities for further improvement and evaluate the extent to which new policies may be required or helpful, to strengthen our management approach. Following on from annual sustainability reporting, we submit our Sustainability Report to a large number of **third-party rating platforms** who review and rate our performance and provide useful feedback, which informs our planning for the forthcoming year.

THIRD-PARTY RATINGS



TOP 5%
"GOLD" RATING



LISTED ON INDEX



"AA RATED**"



RATED: LEADER
5th out of 145 tech companies
for overall sustainability
performance



LISTED ON INDEX
SXI Switzerland
Sustainability 25^(R)



2020 OVERALL WINNER
in Consumer Technology
category

*The use by Logitech of any MSCI ESG Research LLC or its Affiliates ("MSCI") data, and the use of MSCI logos, Trademarks, Service Marks or Index Names Herein, do not constitute a sponsorship, endorsement, recommendation or promotion of Logitech by MSCI. MSCI Services and data are the property of MSCI or its information provides, and are provided 'As-Is' and without warranty. MSCI names and logos are trademarks or service marks of MSCI.

STAKEHOLDER ENGAGEMENT

Transparent stakeholder engagement helps us build and maintain lasting relationships with the people who care about our activities and business success.

We acknowledge and support the continued demand for the technology sector to be transparent and disclose pertinent information.

Transparency and engagement in all aspects of business align with our company culture of being open to new ideas and collaborative by nature. We look to foster an environment where we receive and provide candid and constructive feedback and share insight, to help us continually improve.

We subscribe to the Global Reporting Initiative (GRI) definition of a “Stakeholder Group”, and identify stakeholders as entities or individuals that can be reasonably expected to be significantly affected by our activities, products and services; or take actions that affect our ability to successfully implement strategy and achieve objectives

As part of our most recent Materiality Assessment process, and in accordance with the GRI Principle of Stakeholder Inclusion, we have identified six broad stakeholder groups with views and perspectives relevant to our activities:

- Customers, consumers and the public
- Employees
- Regulatory authorities
- Shareholders/Investors
- Special interest groups
- Suppliers & Business Partners

Informal engagement with each of the identified key stakeholder groups occurs throughout the year. Our engagement approach for each Stakeholder Group is outlined in the following table, along with a summary of the key “Topics of Discussion,” which are typically raised by each Stakeholder Group.

Our engagement activities to date indicate no significant concerns with respect to our sustainability approach and performance. Broadly speaking, stakeholders tend to primarily focus on our product performance and economic performance. Queries in relation to sustainability performance tend to relate to requests for evidence of product compliance and queries or surveys by investor advisory firms.

This report provides an overview of our current approach and performance in relation to material aspects of our sustainability management and performance. Additional information is available upon request.

ENGAGEMENT STRATEGY	TOPICS OF DISCUSSION
<p>Customers, Consumers and the Public</p> <p>We engage with customers, consumers and the public via social media platforms, website and online community. We regularly communicate information to the public via press releases, blogs, media events and direct outreach. We receive feedback, directly from consumers and via our network of business partners, including retailers and distributors. We monitor satisfaction ratings, for any customers who engage with our Customer Experience team, using industry-standard Net Promoter Score method. Our FY19 NPS score was 50.</p> <p>Historically we have had a culture of “do, then say”, but in FY20 we made public commitments to consumers and the public, in relation to two key topics of sustainability</p> <p>Commitment with Climate Action: In FY20, we declared our commitment to future generations by setting ambitious sustainability goals for our products, packaging, and operations. We announced our support of the Paris Agreement, pledging to limit our carbon footprint to support the ambitious 1.5°C goal and to be powered exclusively by renewable electricity by 2030. This commitment represents a transformational but natural next step in our sustainability journey. Finally, we committed to expand beyond carbon-neutral operations to carbon-neutral products. All Logitech gaming products are now certified CarbonNeutral®, with additional product portfolios to follow.</p> <p>Carbon Transparency: This year, we pledged to provide carbon impact labels on product packaging across our entire portfolio. We made this commitment, to engage and empower consumers with sustainability information and enable carbon-cognizant purchasing decisions. With this pledge, we hope to catalyze an industry-wide shift to lower carbon products and reduced impact on the environment. Please refer to the Carbon Transparency section of this report, for further information on this exciting new commitment.</p>	<ul style="list-style-type: none"> • Product performance, including warranty process • Customer satisfaction • Product features • End-of-life recycling • Hazardous substances (RoHS, REACH) • Responsible manufacturing • Product Energy Efficiency • Use of packaging • Giving back • Energy and Climate Action
<p>Employees</p> <p>As a global company with a small company attitude, we endeavor to create an open-door environment, where employees feel they can interact at every level without hierarchy or bureaucracy. For example, our CEO invites all new hires to share ideas with him directly, about their first impressions on how we can make the company better. We also launched an online CEO Comment box in 2020, for employees to share ideas or concerns anonymously and unfiltered. Senior Leaders and content experts regularly host “Ask Me Anything” sessions, where no question is off limits and questions can be raised anonymously, in real time.</p> <p>Annual roadshow events are conducted for each region to discuss the company’s priorities and ensure employees understand how their role aligns to company objectives, while also allowing employees’ to share their views, questions and concerns directly with senior leaders. This year, in response to Covid-19 and also in line with our intent to support streaming and broadcasting, we held virtual roadshows to educate and inspire despite employees sheltering in place. In line with our commitment to transparency, all videos, presentations and questions raised were hosted on our company intranet, facilitating further employee views, comments and ongoing engagement.</p> <p>We have always been an open culture, free to share ideas and feedback. In FY20 we wanted to capture employee perspectives with a unique, twice-yearly survey, which not only identified what we do well and where we can work to improve, but also resulted in personalized, ongoing coaching of individuals across Logitech via regular prompts of</p>	<ul style="list-style-type: none"> • Employee benefit and compensation offerings • Employee development opportunities • Company strategy and priorities; vision and values • Company commitment to social and environmental issues • Corporate philanthropy and individual/team charitable opportunities

Stakeholder Engagement

continued

ENGAGEMENT STRATEGY	TOPICS OF DISCUSSION
<p>how small actions can have big impacts. The percentage of employees participating in the December survey was 87%. We also capture a "Happiness Index" within the survey where 89% of employees responded favorably to the questions which constitute the Happiness Index, in our December survey.</p> <p>At our production facility, we conduct regular team meetings and utilize mobile chat, to share company news and leadership updates in local language. More formally, we conduct periodic worker interviews to further collate and understand employee views, provide suggestion boxes and an anonymous whistle-blowing mechanism, which employees can use to submit comments, confidentially.</p>	
<p>Regulatory Authorities</p> <p>As a global company, we respect international and domestic laws in the countries in which we operate. Our global Sustainability team is supported by legal experts who monitor developing legislation and standards across the globe, relevant to current and planned activities.</p> <p>We also report information to relevant authorities, including financial reports and other sustainability-related performance reports. Key regulatory authorities include, but are not limited to, the Chinese Ministry of Environmental Protection (for our production facility in Suzhou, China) and the US Securities and Exchange Commission (for financial reporting).</p>	<ul style="list-style-type: none"> • Hazardous substances (RoHS, REACH) • Compliance with environmental permits • Legal compliance reporting • Conflict minerals • End-of-Life stewardship reporting
<p>Shareholders / Investors</p> <p>Engagements are managed by our Investor Relations team and include our Annual General Meeting, routine conferences and briefings and direct engagements. Annual financial statements, Investor Reports and other pertinent information is shared via the Investor Page of our website.</p> <p>A number of investor advisor groups monitor and report our sustainability performance to potential and existing investors and engage with us when undertaking their periodic sustainability assessments.</p> <p>At our Analyst and Investor Day, we presented the acceleration of Logitech's sustainability impact and commitments, to a global audience.</p>	<ul style="list-style-type: none"> • Financial performance • ESG (Environment, Social and Governance) performance • Energy and climate action • Sustainability reporting • Supply chain management
<p>Special Interest Groups</p> <p>Special Interest Groups can include industry bodies, Non-Governmental Organizations (NGOs) and other groups with particular interest in certain aspects of sustainability performance. We are members of the Responsible Business Alliance (RBA). The RBA identifies Special Interest Groups of relevance to our sector and helps guide engagement processes governed by Chatham House Rules. Page 24 provides an overview of the key industry initiatives and industry bodies that we maintain membership in. We consider the public views of a number of Special Interest Groups, as part of the External Factors Review and Materiality Assessment underpinning this Sustainability Report. Please refer to the Materiality Assessment section for further information.</p>	<ul style="list-style-type: none"> • Sustainability performance at our production facility • Supply chain management • Energy and climate action • Worker safety, health and wellbeing • Human rights and labor

ENGAGEMENT STRATEGY	TOPICS OF DISCUSSION
<p>Suppliers & Business Partners</p> <p>We regularly liaise with distributors, retailers and other business partners, to understand customer needs and ensure products are brought to market in a manner that reflects our sustainability expectations and good practice requirements.</p> <p>We audit our major suppliers a minimum of once a year and adopt a partnership model, which engages suppliers in collective brainstorming, to co-develop solutions. Sustainability performance requirements are communicated and embedded into contractual arrangements with suppliers. Facing the challenging context of Covid-19, we continued to prioritize supplier engagements with our annual Supplier Day taking place as virtual sessions, to set sustainability expectations and engage in dialogue and transparent Q&A. In our May 2020 suppliers meeting, we presented our approach to pervasive sustainability and our expectations of our partners for carbon reduction, renewable electricity carbon reporting and overall designing for sustainability.</p>	<ul style="list-style-type: none"> • Ethical code of conduct • Responsible marketing and product labeling • Responsible manufacturing • Hazardous substances (RoHS, REACH)

MATERIALITY ASSESSMENT

We focus on the issues that really matter. Our Materiality Assessment helps us make sure we continue to focus on the areas where we can have the most meaningful impact and also the areas of greatest interest to our stakeholders.

MATERIALITY ASSESSMENT PROCESS

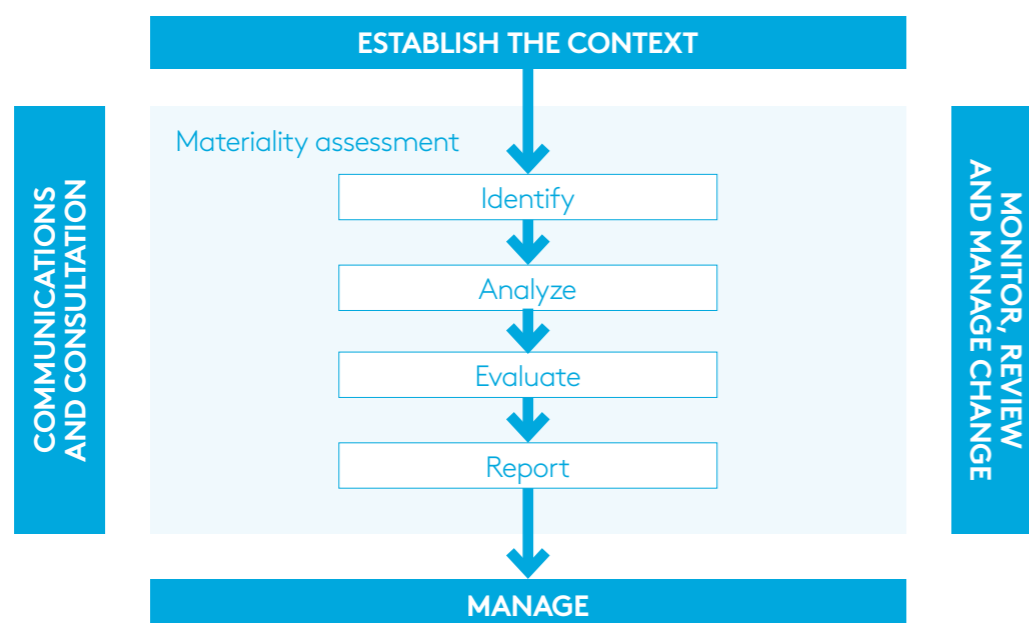

Our materiality assessment process reflects GRI101, GRI102 and GRI103, as well as ISO 31000 (i.e. the international good practice standard for risk and opportunity identification, analysis and management). The overall process is shown in the figure above and the key steps can be summarized as follows.

Establish the context

To establish the context of this report and our materiality assessment, we carry out an External Factors Review of publicly available data sources, to understand current good practice standards or benchmarks, stakeholder perceptions, and societal views,

relevant to our sector. The EFR process is a year-round process, with information and insights gathered, as they arise, over the course of the year. A concerted and systematic review of the information is carried out in tandem with sustainability reporting each year.

We engage with stakeholders directly and indirectly, as described in the [Stakeholder Engagement](#) section of this report. Our approach takes into account emerging and evolving sustainability trends and material stakeholder concerns as reported by the public, media, thought leaders, stakeholders, risk alert services and business partners. We identify existing and emerging megatrends relevant to our sustainability performance and these megatrends establish the context for this report.

In each section of this report, we report our performance in relation to broader concepts of sustainability, previous generations of product or historic performance and relative to good practice standards and expectations, which we commit to uphold.

Identify

To identify issues of concern, we review existing, sector-specific materiality frameworks, which have been compiled by independent third-parties, following multi-stakeholder interview and engagement exercises. Examples include those compiled by the Sustainability Accounting Standards Board (SASB) and the Global Reporting Initiative (GRI). In addition, we review the Sustainability Report of peer companies, to identify emerging trends, stakeholder expectations and material issues, which have been identified by peer companies in our sector or comparable sectors. We also review any information requests,

surveys or queries received during the preceding year from each of our Stakeholder Groups. This helps us streamline the communication of pertinent information, by integrating any new data that was generated during the year, into the report so that all relevant information is consolidated and consistent in one report.

Analyze

As an outcome of this process, we typically identify a wide range of sustainability issues, which warrant further consideration. The key issues are clustered into groups ("Sustainability Topics") and the nomenclature of each group is simplified, to ensure the meaning can be broadly understood and resonates with our stakeholders. Each topic is then analyzed and scored to identify those of material interest.

When analyzing and defining materiality, we considered two key dimensions, as advised by GRI:

- **Dimension X:** Potential for Sustainability Impact: areas where we have a meaningful and significant economic, environmental and social impact; and
- **Dimension Y:** Stakeholder Importance: aspects of our performance that are important to stakeholders and could influence their assessment of our performance or decision-making.

When assessing Dimension X (Potential for Sustainability Impact), we consider our:

- alignment with our purpose, values, goals and standards;
- our business model and associated level of influence and potential for impact;
- our innovation potential and capabilities around design, engineering, supply chain and product development;
- our potential to make a meaningful contribution to important global movements towards sustainability and megatrends in societal expectations;
- our capacity to enhance user experience, including the sustainability experience of our customers and consumers, in particular; and
- opportunities for value creation, beyond financial value e.g. compliance assurance, innovation, market differentiation, reputational value and brand equity.

When assessing Dimension Y (Stakeholder Importance), we consider the views and perspectives of each of our six Stakeholder Groups. We consider

- comments views and information requests submitted to Logitech directly;
- information gathered while engaged in continual collaboration with various stakeholder groups as described in the [Stakeholder Engagement](#)

Materiality Assessment

continued

section and as part of our industry memberships; and

- broader stakeholder views and interests in our sector as a whole, as identified as part of the External Factors Review process.

Evaluate

The resulting scores are evaluated from low to high, to make an overall determination of materiality. Not all material topics are of equal importance, and the emphasis within this report reflects their relative priority.

Report

The result of the materiality assessment process is reported in the following figures. The first figure shows the materiality of

specific Sustainability Topics. The second figure shows the value chain boundary for each topic.

Typically, each sustainability topic is reported in a report section with the same name. Three notable exceptions were made, to avoid duplicate reporting of some cross-cutting topics:

Water in our own operations and waste in our own operations is addressed in the Responsible Manufacturing section of this report, along with other aspects of environmental performance. Health and safety performance in both our factory and offices is reported in the Safety, Health and Wellbeing section;

Human Rights and Labor in our own production facility is addressed in the Human Rights and Labor section of this report.

All other aspects of supplier sustainability performance (including social, environmental, health, safety, ethics and human rights performance) are reported in the Supplier Development section.

Where relevant, the scope of each report section is clearly defined and cross-sections to additional, related sections are highlighted and included. A GRI and SASB Index is also available from our Reports and Resources Webpage, to show where specific GRI/SASB metrics are reported.

MATERIALITY ASSESSMENT

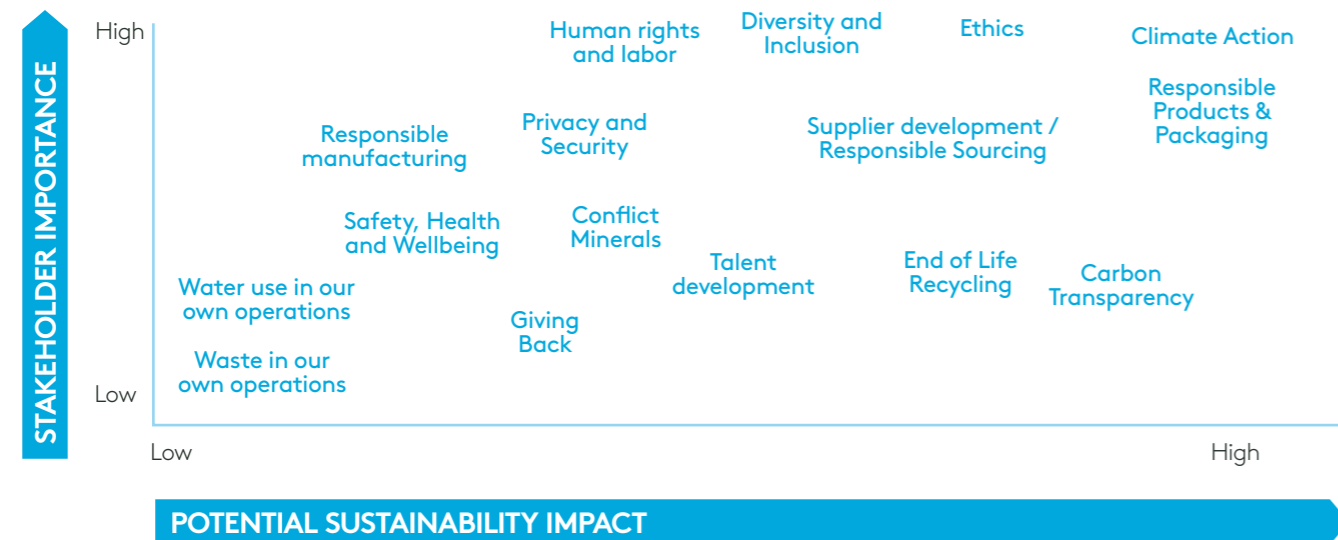

VALUE CHAIN BOUNDARIES FOR MATERIAL ASPECTS

MATERIAL ASPECTS	VALUE CHAIN				
	Supply Chain	Logitech Manufacturing	Sales & Distribution	Product Use	Product End-Of-Life
Ethics	✓	✓			
Safety, health and wellbeing	✓	✓			
Human rights and labor	✓	✓			
Diversity and inclusion	✓	✓			
Supplier development	✓				
Talent Development		✓			
End-of-life recycling					✓
Climate Action	✓	✓	✓	✓	✓
Conflict minerals	✓				
Privacy and Security		✓			
Responsible products	✓	✓	✓	✓	✓
Responsible manufacturing	✓	✓			
Giving back		✓			
Carbon Transparency	✓	✓	✓	✓	✓

PRODUCTS AND THE ENVIRONMENT



“

Everything we make has an impact on the world. We pledge to future generations that we will use our resources and leadership to make a positive and sustainable impact.

Prakash Arunkundrum
Head of Global Operations

”



For us at Logitech, sustainability is pervasive across all our activities and a reflection of our culture. We are reimagining product design throughout all lifecycle phases. Since last year, we have made multiple forward-looking public commitments and made good progress with our key environmental goals of improving carbon, toxicity and circularity of our products and our operations. You will see many examples of this progress throughout this report.

Our climate actions efforts are focused on 3R's - Reduce, Renew and Restore. Our goal is to Reduce our carbon footprint in support of the 1.5 °C goal to reduce global warming; Renew our footprint by using 100% renewable electricity; and what we are not able to reduce or renew we will Restore through investments in forestry while supporting climate-impacted communities.

To achieve our carbon reduction goal we have developed a number of lifecycle carbon, sustainable material and circularity analysis toolkits to inform and measure our progress. Our design for sustainability principles are integrated into our product development process. We have invested in new materials development and advanced sustainability research, in partnership with industry groups and academic institutions. These investments are helping us transition from product-level improvements to platform-level transformations.

We are increasingly using post-consumer recycled plastic resins in our products to create more circular supply chains and lower our product carbon footprint. We have established several packaging design principles to remove plastics and reduce weight, and are moving to FSC[®]-certified paper and vegetable-based ink.

88% of our global electricity demand is now sourced from renewable sources, nearing our RE100 commitment of 100% renewable electricity and we are working with our partners to make similar progress. We eliminate 131 tons of PVC contributing to our goal to be 100% PVC-free. We are 98% to our goal of complete conflict mineral certification and already at 100% for tungsten and tantalum. Last year we established a global recycling standard for end-of-life devices and have directly enabled recycling of over 50,000 tons of devices since CY10.

Our entire gaming portfolio, corporate travel, and our production facility are carbon neutral. We took this a step further by becoming the first consumer electronics company to commit to carbon transparency. We will share the lifecycle carbon footprint of all our products to drive better design decisions internally and for our consumers to better understand their carbon consumption. We are advocating for our industry peers to join us in carbon transparency and

will share our know-how.

Externally, our approach is resonating with the industry and partners. The UN- sponsored World Benchmark Alliance has included Logitech in the SDG2000, a list of companies with the greatest potential to influence a more sustainable future. In 2019 and again in 2020, we won the World Finance Magazine Sustainability Award for our sector. We are also listed as a Leader in technology by Sustainalytics and maintained our inclusion on the FSTE4GOOD Index and Swiss SIX Sustainability Index as one of the "top 25 most sustainable Swiss companies."

For the first time in an interconnected world, we witnessed the impacts of a global pandemic. In this time, I have seen how we as humans can adapt and positively improve our life on this shared planet. This sustainability report stands to reflect a mix of what we have done, what we are committed to doing, and how we will act to help others along the way. We know there is much to do. We remain committed to sharing openly and to learn from others. I invite you to write to us with any comments or suggestions you may have for us at sustainability@logitech.com.

Thank you

Prakash Arunkundrum
Head of Global Operations

DESIGN FOR SUSTAINABILITY (DfS)

Our goal is to design products that deliver great user experiences while minimizing our environmental footprint and enhancing our positive social handprint. For us, a truly sustainable design considers environmental and social impacts from the moment raw materials are sourced right through to end-of-life.

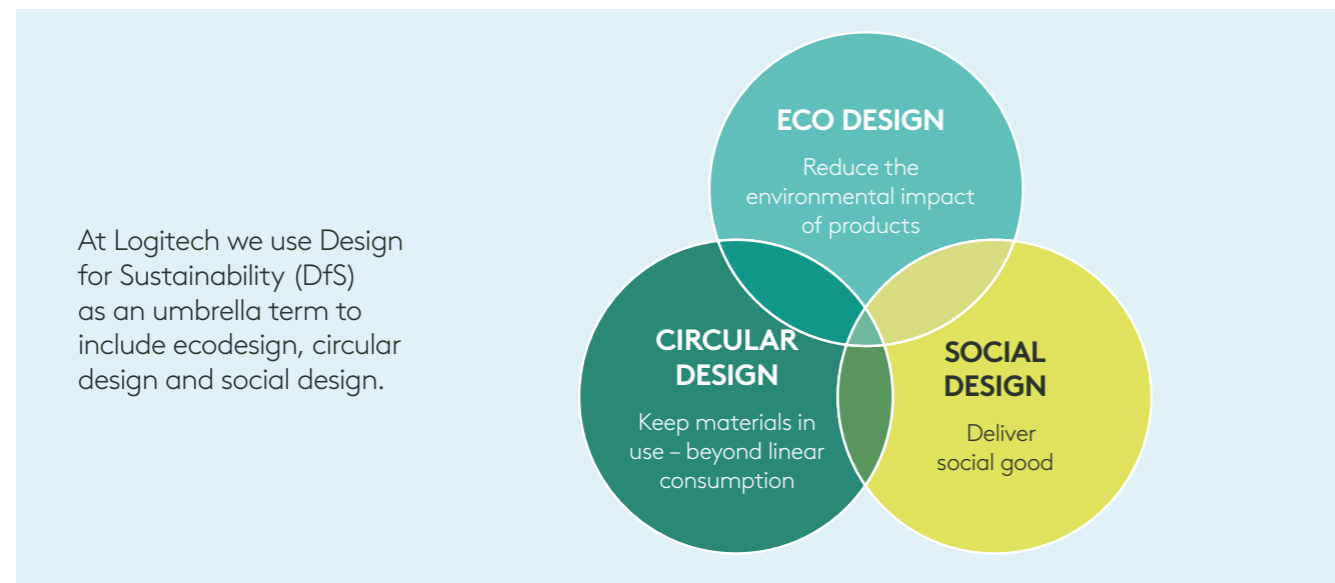

Ecodesign is about impact reduction through the design of lighter, more efficient products and packaging that use lower impact materials, requiring less energy to source, manufacture, distribute and use.



The environmental impact of the K400 Professional is reduced through the use of post-consumer recycled plastic.

Circular design is focused on the goal of ensuring that products that are loved and last for as long as possible by optimizing for longevity, repairability, reuse and, eventually, recycling at end of life.



The C40 TR Controller delivers an extended product life by being designed for durability and repair.

Social design considers the positive social impact of our products - this goes beyond the traditional user experience concerns to engage with the role our products can have in empowering positive change.



The Adaptive Gaming Kit has a positive social impact by improving accessibility to gaming for users of all abilities.

Our Design Process

We realize that the biggest opportunities to reduce environmental impact arise early in the design process, when key decisions about a product are made. So we have integrated environmental impact assessment processes at the front end of product development.

In FY20 we updated our design process to incorporate environmental targets alongside other traditional product development goals like cost, user experience and technical feasibility.

Sustainable Design Principles

Incorporating design for sustainability into product

development involves navigating the complex intersections of technical product performance, user experience, business viability and environmental and social impacts. In FY20 we established 15 key sustainable design principles to guide product teams working to meet our goals for sustainability.

Sustainability is tracked at project gates

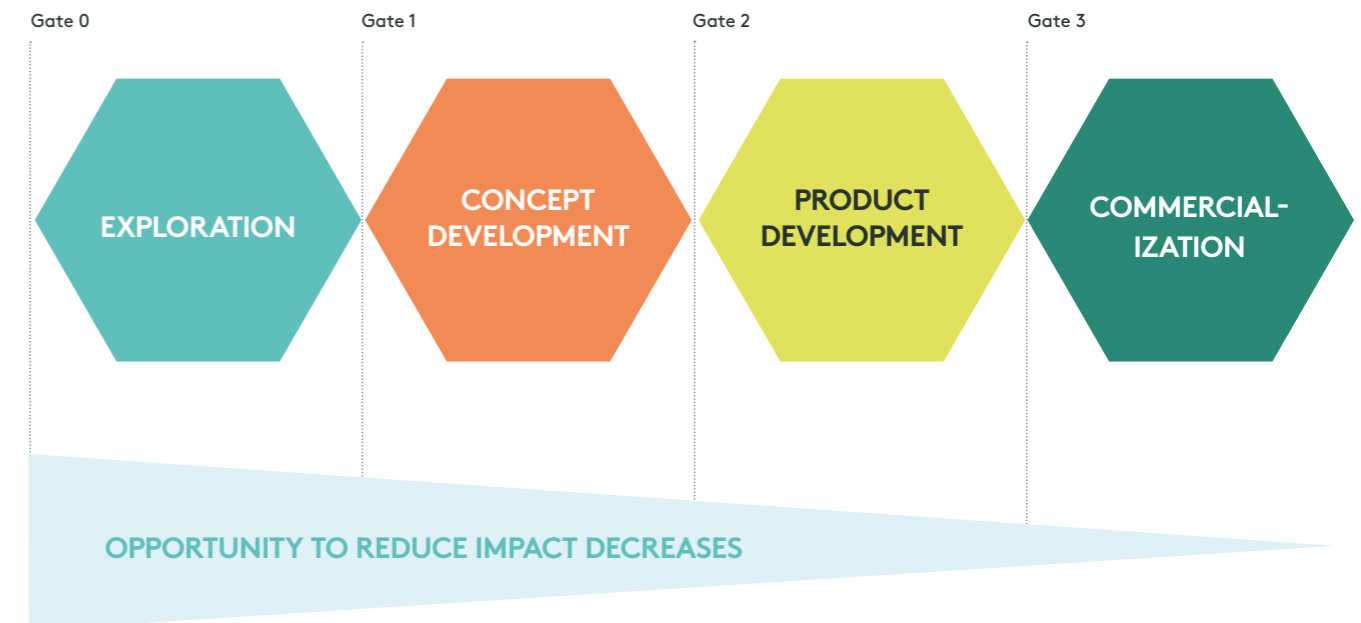

In our design process, the environmental performance of a design direction relative to its target is made visible at each project gate.

Design for Sustainability (DfS)

continued

Sustainable Design Principles

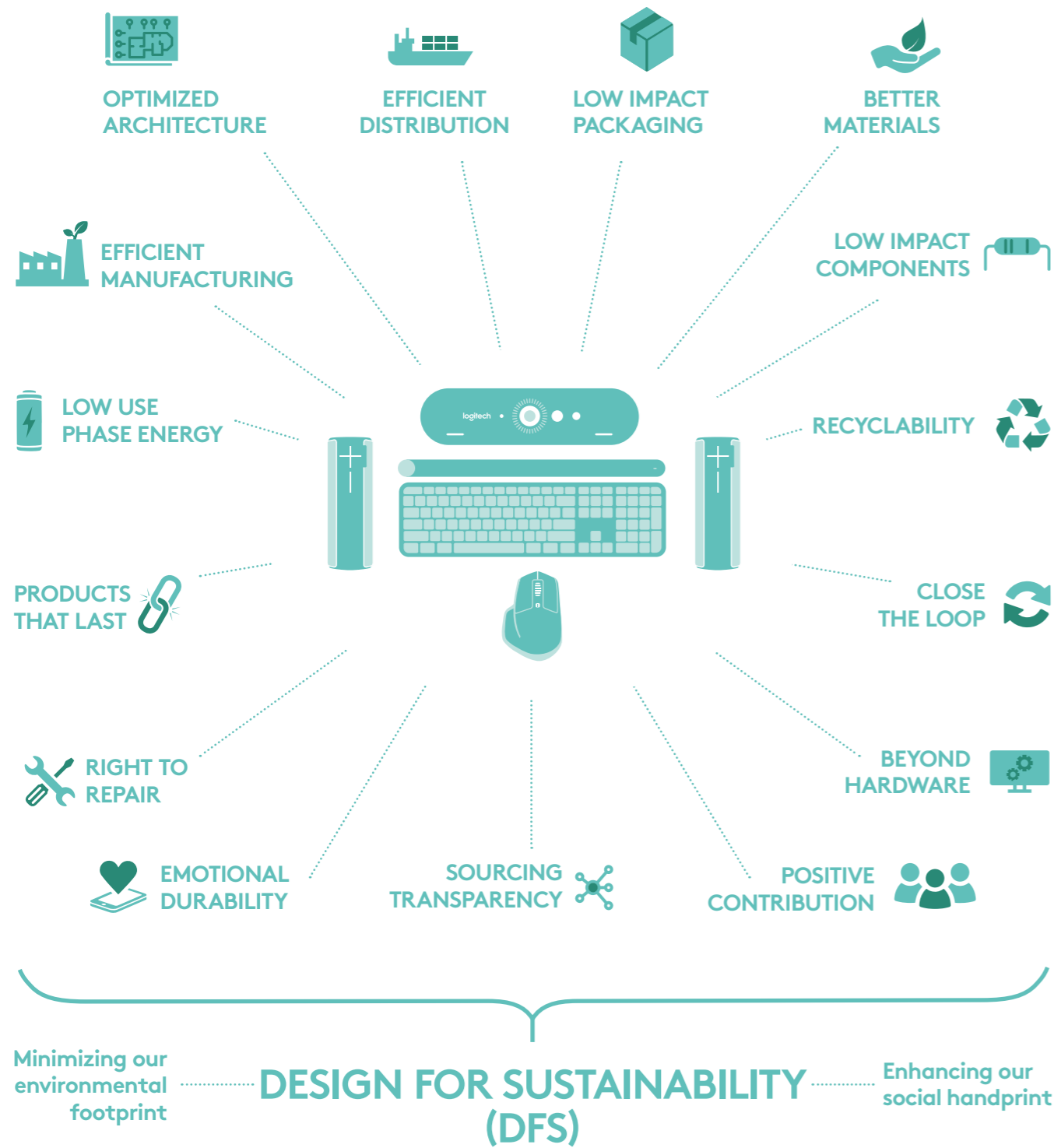

Measuring Sustainability

We translate the likely environmental performance of our designs into carbon, toxicity, circularity and other key indicators which are then used to guide design decisions. Tracking, these metrics across our product portfolio allows us to gauge our progress and to set meaningful

targets for environmental impact reduction.

To support decision-making during the design process we have developed internal guidelines, tools and calculators. More detailed insight into two example tools is given on the following page.

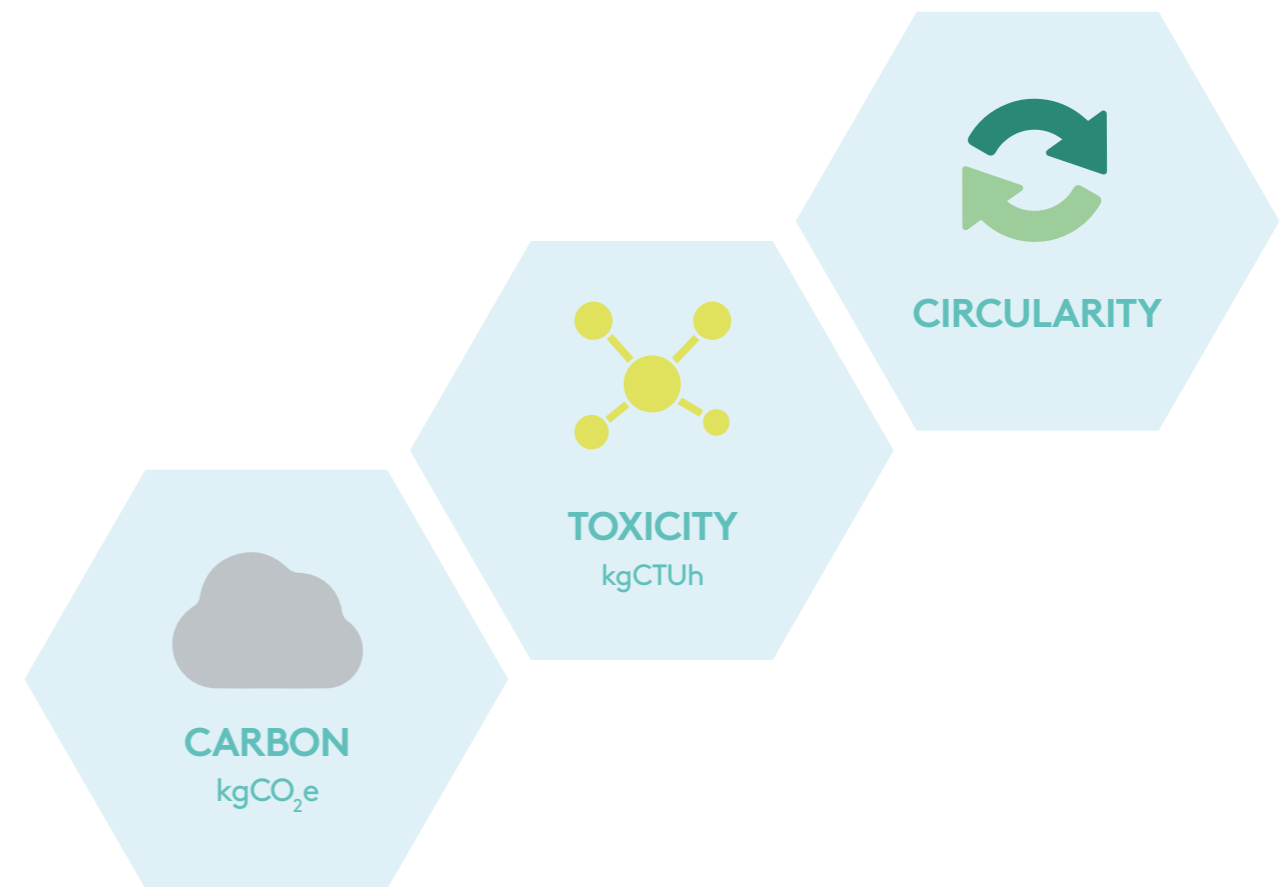

Design for Sustainability (DfS)

continued

TOOLS

PRODUCT IMPACT CALCULATOR

In FY20 we developed a Product Impact Calculator using standardized LCA data for our commonly used materials and components. This tool presents a quick snapshot of competing design directions very early in the design process enabling our design teams to rapidly assess product architectures and make choices to improve a product's environmental performance.

Carbon impact assessment

A carbon impact assessment example between two competing design directions

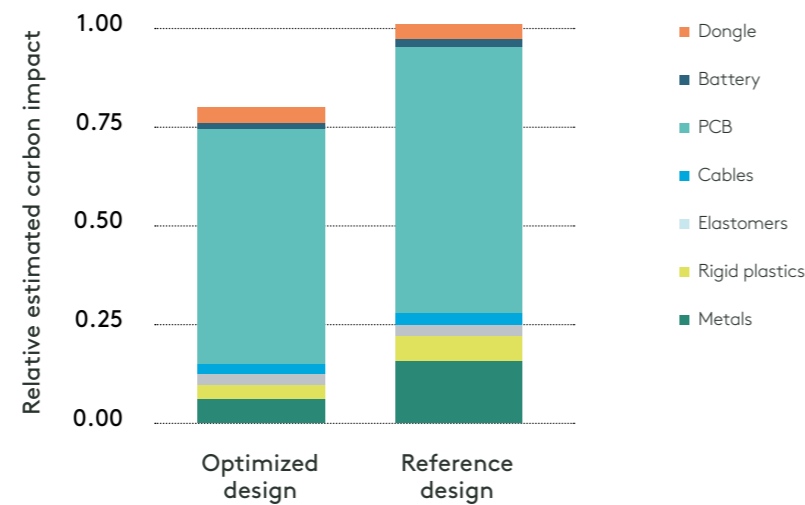

LCA Capability

Our DfS tools are grounded in a life cycle approach to the impact of our products. We describe our product life cycles as being divided into five stages as shown below.

The ability to measure the impact of our products across the lifecycle is underpinned by our internal Life Cycle Assessment (LCA) capability which is guided by International Standards ISO 14040 and ISO 14044.

Throughout FY20 we have partnered with the iPoint Group, which are internationally recognized

leaders in LCA, to advance this capability even further by:

- evolving our insights into the impact of materials, components and processes not currently included within commercially-published LCA datasets.
- Diving deep into specific focus areas to rapidly assess the environmental impact of a new technologies for which published data may not already exist
- building a standardized approach to the lifecycle modeling of our products to bring efficiency and transparency to our LCA capability.

We enjoy working with Logitech's highly motivated team and are impressed by their ambitious commitment to bring carbon transparency for their consumer electronics to the next level.

Martina Prox, Sustainability Strategy at iPoint

CIRCULATORY ASSESSMENT TOOL

In FY20 we established our Circulatory Assessment Tool as a semi-quantitative scoring system for the circularity of a design. It captures how a product is likely to perform in terms of longevity, reuse and recyclability. The tool was developed to reflect stakeholder views, legal megatrends, good practice standards such as EPEAT, IEEE 1680.1, ECMA 341 and international eco-labeling systems including Blue Angel, EU Ecolabel and others.

Circularity assessments

Our Circulatory Tool allows us to quantify how well a particular product architecture performs early in the design and allows us to focus on areas for improvement.

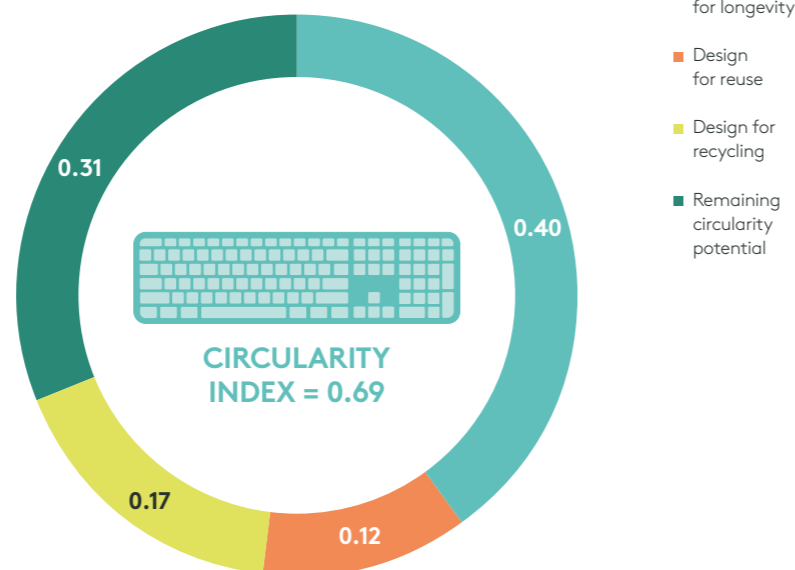

Life cycle assessment



Design for Sustainability (DfS)

continued

iNEMI Collaboration

At Logitech we recognize that collaboration amongst industry and academic/research institutions is critical. Throughout FY20 Logitech contributed to the International Electronics Manufacturing Initiative (iNEMI) eco-impact estimator project. iNEMI is a not-for-profit R&D consortium of approximately 90 leading electronics manufacturers, suppliers, associations, government agencies and universities. Over the past decade the iNEMI industry consortium has worked to develop and improve an eco-impact estimator for the ICT (Information and Communications Technology) sector, based on a simplified approach. Together with other leading electronics companies, Logitech has contributed to this effort by providing time, data and technical input and feedback.

BETTER MATERIALS

At Logitech, the selection of materials for the design of a product is informed by environmental impact alongside the traditional considerations of cost, technical performance and user experience. Our insights into top selling products help us to understand that plastic and metals are among our top utilized product materials by weight. These insights allow us to focus our energy and attention on material sets which have the potential for most positive impact.

Sustainable Materials Roadmap

From our LCA work we know that our sustainability ambition demands more than what many currently available materials can offer. So, in FY20 we built a cross-functional working group to develop a roadmap

Our starting point in the collaboration with Logitech was the premise that putting sustainability at the front-end of the design process should trigger opportunities to realize the potential of materials.

Chris Lefteri, Director,
Chris Lefteri Design Ltd

of sustainable materials for the future of Logitech products.

The expertise that was needed required input from teams both inside and outside Logitech. External partners involved in this program included design studio **Chris Lefteri Design** and Advanced Materials and BioEngineering Research Center **AMBER**. This working group took environmental sustainability as a starting point and injected technical, design and supply chain perspectives to identify promising available and emerging rigid plastics, elastomers and fabrics. The materials identified by this program are now being trialed for implementation in upcoming projects.

EPFL Collaboration

In April 2020, we joined with Nestlé, SIG and other industry players, to fund research into more sustainable materials at

EPFL, the Swiss Federal Institute of Technology in Lausanne, Switzerland. Together with other industry players, we have committed to providing **five million Swiss francs** over ten years. The funding will support a new chair for sustainable materials research within EPFL's Institute of Materials. The chair, to be appointed as a tenure-track assistant professor, will be responsible for developing and implementing a new research program on sustainable materials at EPFL. Research areas of interest will address critical questions, such as the overall environmental impact of materials and the exploration of bio-based, bio-degradable and recyclable materials, including high-performance paper-based barrier materials, that could help to address environmental concerns about plastic packaging, and more.

We are excited to collaborate with EPFL and other industry players to deliver breakthrough research into more sustainable materials. We will collectively fund research by providing five million Swiss francs over ten years. This is the type of research that we need to meet the world's critical, environmental challenges.

Prakash Arunkundrum,
Head of Global Operations

Breakdown of Top Selling Products (By Weight)

- 1 Plastic parts 38%
- 2 Paper packaging 32%
- 3 Metal 13%
- 4 Cables 5%
- 5 PCB 4%
- 6 Plastic packaging 3%
- 7 Batteries 3%
- 8 Rubber 1%
- 9 Other 1%

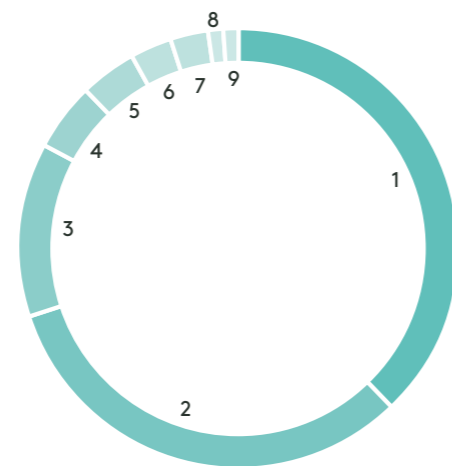

Case Study

Our Recycled Plastics Program

We want to make Logitech products more circular. Virgin materials should be avoided, in favor of renewable materials. We use post-consumer recycled plastic, to give a second life to end-of-life plastic and help reduce our carbon footprint.

This year, we continued to use PCR in the C930E webcam and M275 mouse that we launched last year, and we introduced an additional three Logitech products to our PCR portfolio: the K400 keyboard, the Hyperboom speaker and the M100 mouse.

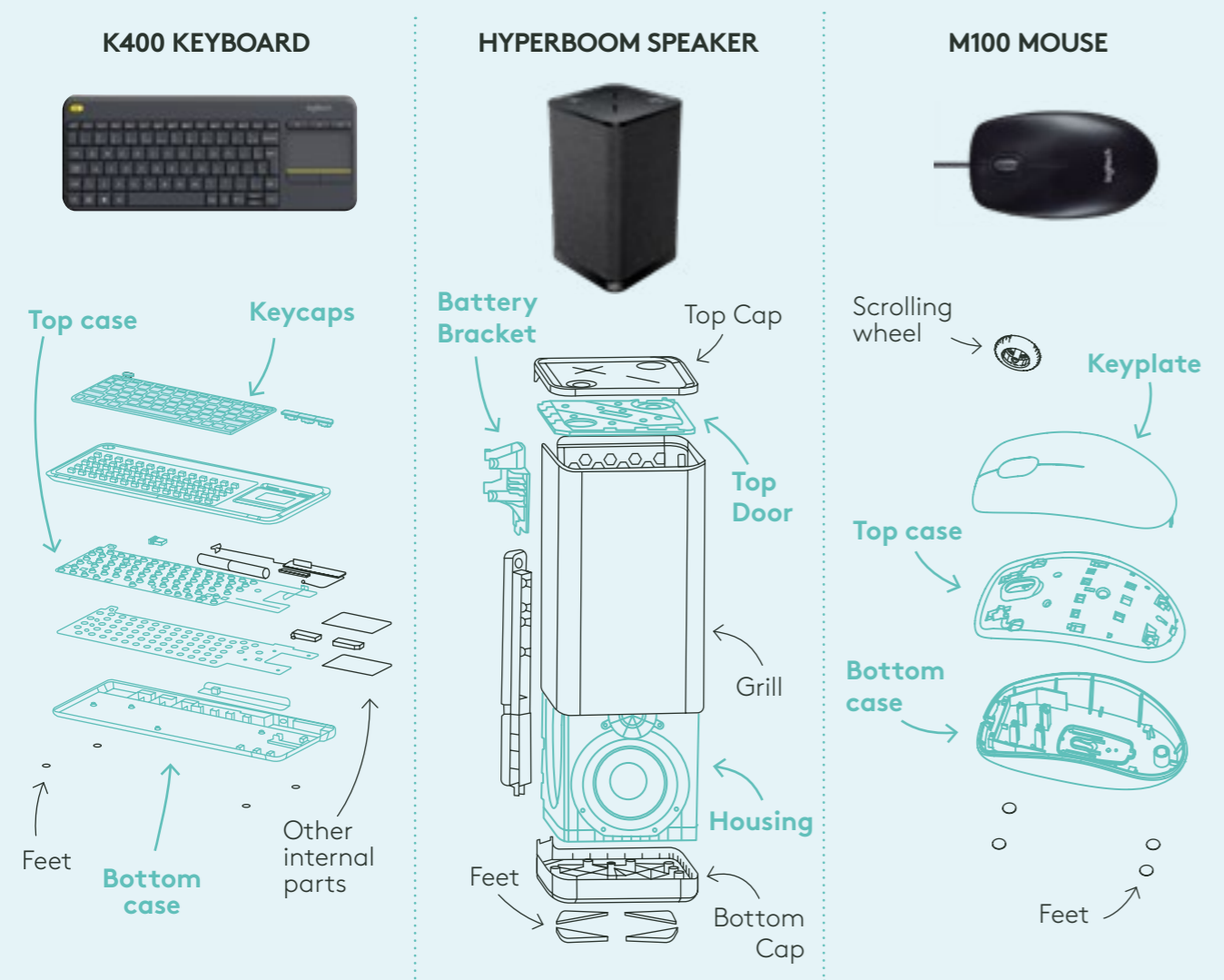
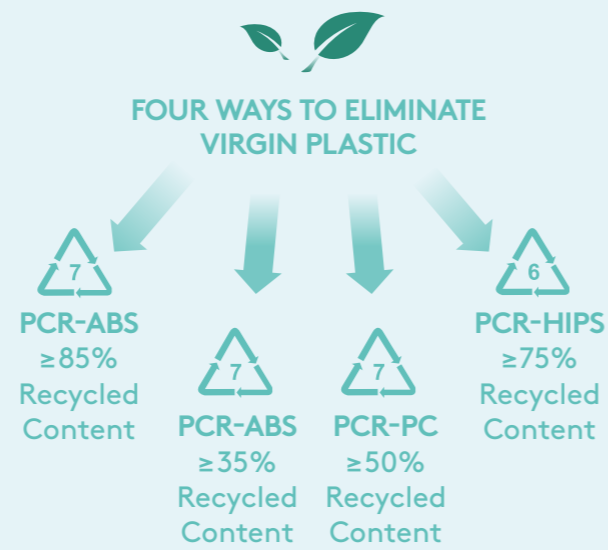

MATERIALS
■ PCR ■ Virgin Plastic

ESTIMATED ANNUAL SAVINGS

273 t
of virgin plastic eliminated with PCR

524 t
carbon footprint eliminated

RESPONSIBLE PACKAGING

Packaging is a critical component of our products - it is the first touch-point for user experience and is key to delivering products to the market safely. Our goal is to optimize the sustainability of our packaging while also ensuring a great out-of-the-box experience.

We consider the sustainability of our packaging designs up-front in the packaging development process when key decisions about packaging materials and structures are being made. We analyze carbon, toxicity, water usage and recyclability of our materials across the full lifecycle to drive continuous improvement.

In FY20 we further evolved our packaging DfS capability in three important ways:

1. We released internal sustainable packaging design guidelines. Drawing on international best practice, these guidelines help to drive a consistent approach to sustainable packaging design across our full portfolio.
2. We embedded the use of Compass (packaging-focussed LCA software) within the packaging design process. This approach enables us to rapidly assess lifecycle carbon, water and other environmental indicators during each design iteration,

thereby driving significant improvements in new packaging designs compared to previous generations.

3. We evolved our recyclability guidelines. By working closely with our international recycling partners we have further developed our ability to optimize the recyclability of our packaging.

Our packaging is PVC-free and, wherever possible, we avoid other eco-toxic materials that inhibit recycling. We also carry out periodic packaging reviews to identify opportunities for optimization. In the last year, we identified and pursued a number of opportunities to reduce the size, plastics and weight of packaging in top-selling products. These weight reductions were achieved through the use of alternative materials (primarily paper, to replace plastic), and improving packaging efficiency. The following infographic provides a flavor of some of the weight and carbon footprint improvements we achieved in FY20.

FY20

LAUNCH OF LOGITECH PACKAGING DESIGN GUIDELINES





3 NEW PRODUCTS LAUNCHED WITH FSC-CERTIFIED PACKAGING



The mark of responsible forestry

Responsible packaging

continued

-  Total weight of packaging
-  Total weight of Plastic packaging
-  Carbon footprint
-  Lifecycle water use

CASE STUDIES

Eco impact compared to previous generation

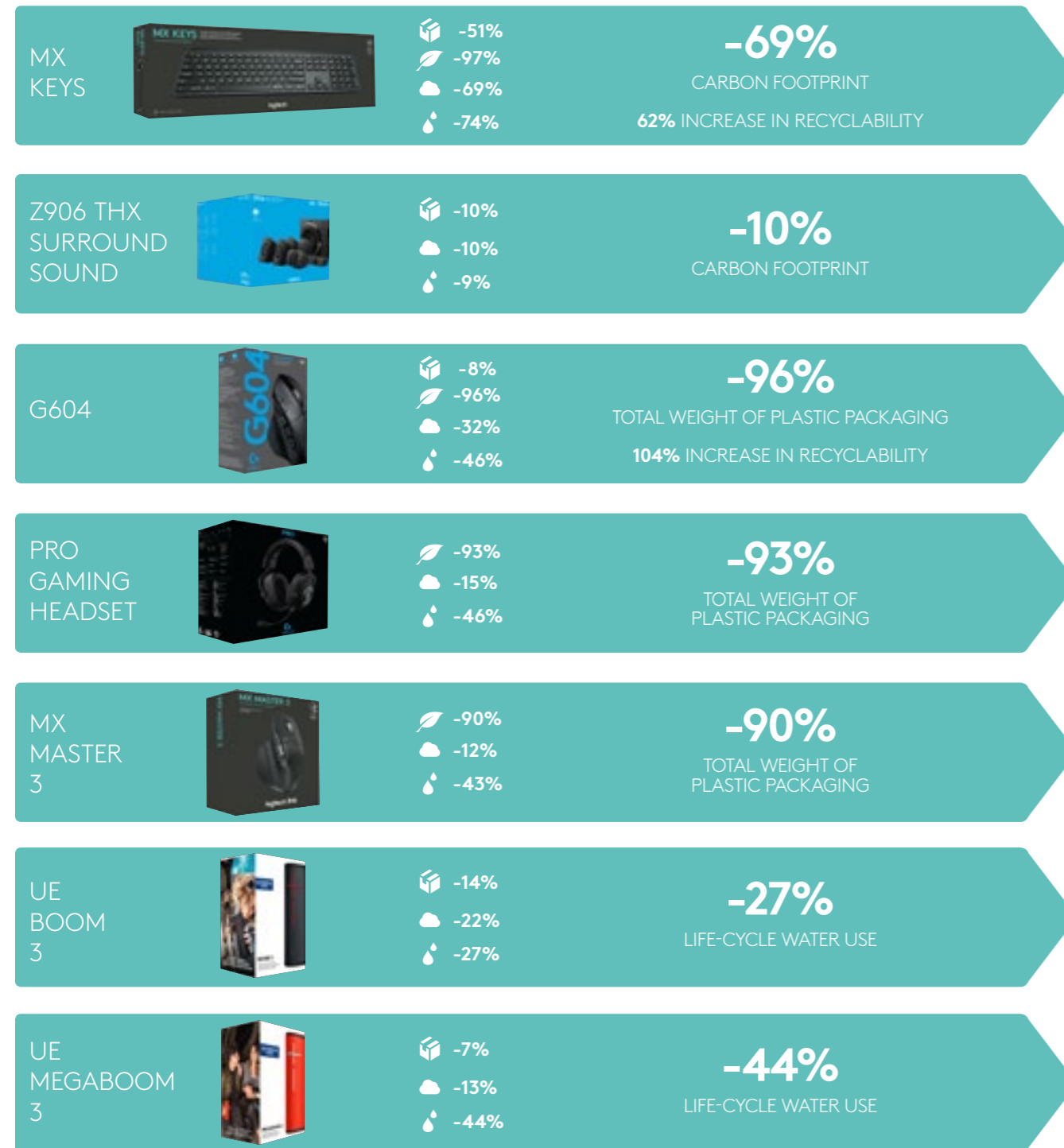

Eliminating Virgin Plastic

Single-use virgin plastics is plastic which is designed to be used only once before being quickly disposed of. A staggering 80% of single-use plastic waste ends up in landfills or in the environment. While we have made significant progress in recent years to eliminate single-use virgin plastic, we recognize the need to step up our efforts. We implemented a number of key initiatives in FY20 to address this issue and we are working to

develop further policy to guide our decision-making in this area.

Recycled Plastic in Clamshell Packaging: Over the last year, we have also transitioned a number of our plastic clamshells to post-consumer recycled (PCR) plastic. Our team of packaging engineers experimented with different percentages of virgin and recycled content to ensure the clamshell material continued to be suitable for our automated packaging process and no negative impact on

consumer experience occurred (the higher the recycled content, the more discolored and brittle the plastic can become). As a result, we replaced half of the plastic components in our mice clamshells with 30% PCR plastic, resulting in 550 tons/year of virgin material replaced. While we are proud of this innovation, we want to explore brown box alternatives to clamshells, where appropriate.

USB Unifying Receiver: In FY20, we reviewed the design of our USB Unifying Receiver. This product was originally packaged in a virgin plastic clamshell and we refreshed the packaging design to eliminate all plastic packaging, in favor of a 100% paper-based solution, using FSC-certified paper packaging.



IMPACT ASSESSMENT

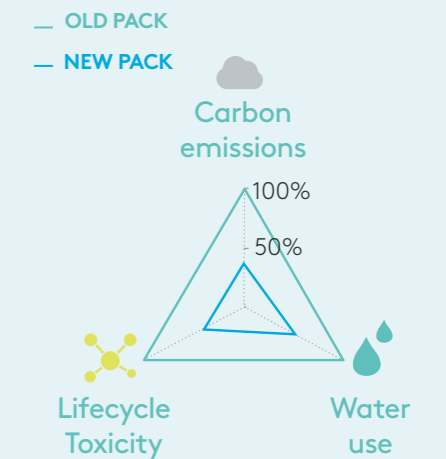

BETTER DESIGNED FOR SUSTAINABILITY

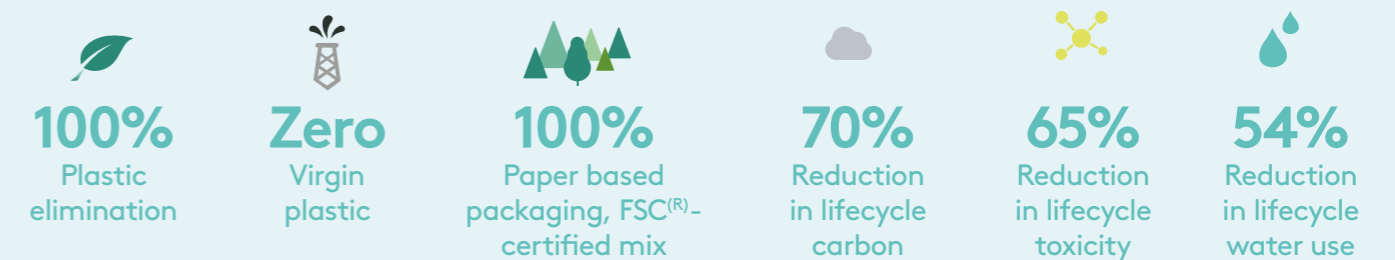

Case Study

Our FSC Program

Using FSC-certified packaging to supporting responsible management of the world's forests.

Our FSC-certified program continues to grow each year. This year we continued to sell the MX Master 3 mouse (launched last year) and also launched the MX Keys keyboard and ERGO K860 keyboard with FSC-certified packaging. As we developed these products, we made every opportunity to eliminate virgin plastic and increase recyclability.



The mark of responsible forestry

MX MASTER 3

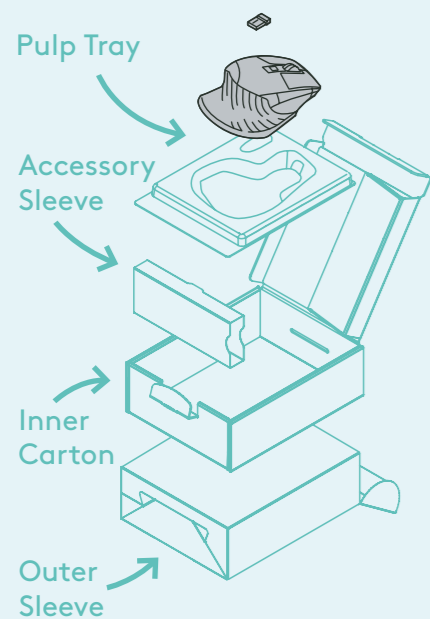

MX KEYS

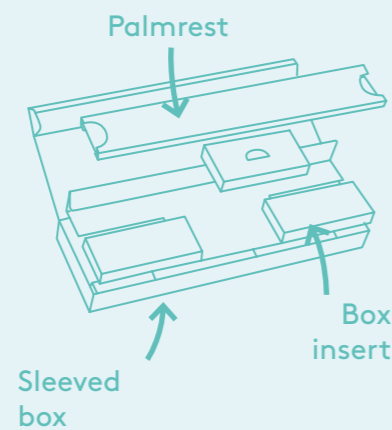
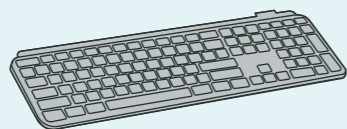

ERGO K860

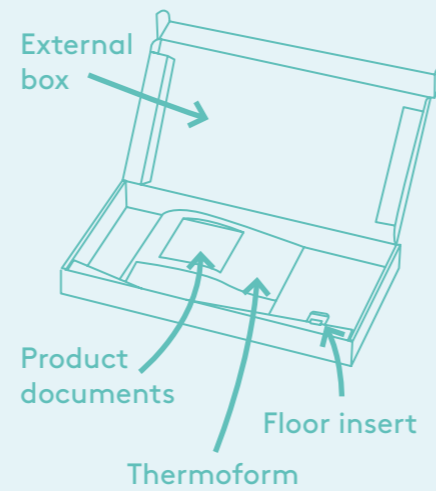
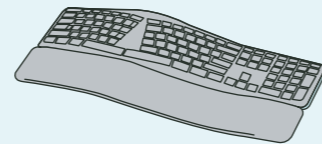

MATERIALS

■ FSC-certified packaging

ESTIMATED CY19 SAVINGS

Significantly reduced use of virgin plastic

138 tpa
FSC-certified packaging

AVOIDING TARGETED SUBSTANCES

Manufacturing of computer peripherals and electronic devices requires a diverse mix of hundreds of parts, materials and components. The materials we use in our products are produced by a supply chain that extends across the world.

As a responsible company, we consider the full life cycle footprint and handprint of our products. We work with our suppliers to review material specifications, test products and components, and identify potential risks to human health or the environment across the full life cycle of our products. We consider environmental impacts beyond our sourcing and manufacturing operations, taking into account typical end-of-life scenarios.

Product compliance is critical to our success as a company. Any non-compliance with legal requirements worldwide could potentially delay market access or damage our relationships with suppliers, and our reputation with customers.

To address these potential risks, we proactively monitor product compliance obligations relevant to the management of toxicity, including chemicals, materials and substances. Our global Sustainability team includes legal experts who work with external advisers to track developing legislation across the globe

and complete periodic External Factor Reviews (EFRs) to identify regulatory megatrends and stakeholder concerns regarding chemical toxicity worldwide.

In reality, our commitment to safe and non-toxic electronics extends beyond simply considering legal requirements. We proactively adopt policy positions that reflect our commitment to the precautionary principle and preventative measures to eliminate, manage and control the use of certain "Targeted Substances" in our manufacturing process and products.

Our General Specification for the Environment (GSE), or "green procurement" standards

We formalized the prohibition and restriction of chemicals, materials and substances in 2002 with the introduction of our General Specification for the Environment (GSE) (i.e. green procurement) standards. These standards identify the substances that

we prohibit, restrict or require declarations for, as well as our labeling requirements. Compliance with our GSE is an explicit requirement in our supplier (contract) agreements for the procurement of goods and services. During FY20, all products on the market complied with our GSE requirements for the management of Targeted Substances.

Since 2002, our GSE standards have developed to reflect evolving legal requirements, regulatory megatrends, benchmarking of peer company approaches, review of stakeholder concerns and international good practice, including IEC 62474 and the RBA Code of Conduct.

A summary of some of the key milestones in our GSE's evolution is shown in the following figure. As shown, we regularly expand and evolve our GSE - to drive the reduction of our supply chain environmental footprint and drive the use of safer and more environmentally-friendly alternative materials.

Avoiding Targeted Substances

continued

GENERAL SPECIFICATION FOR THE ENVIRONMENT (GSE) DEVELOPMENTS

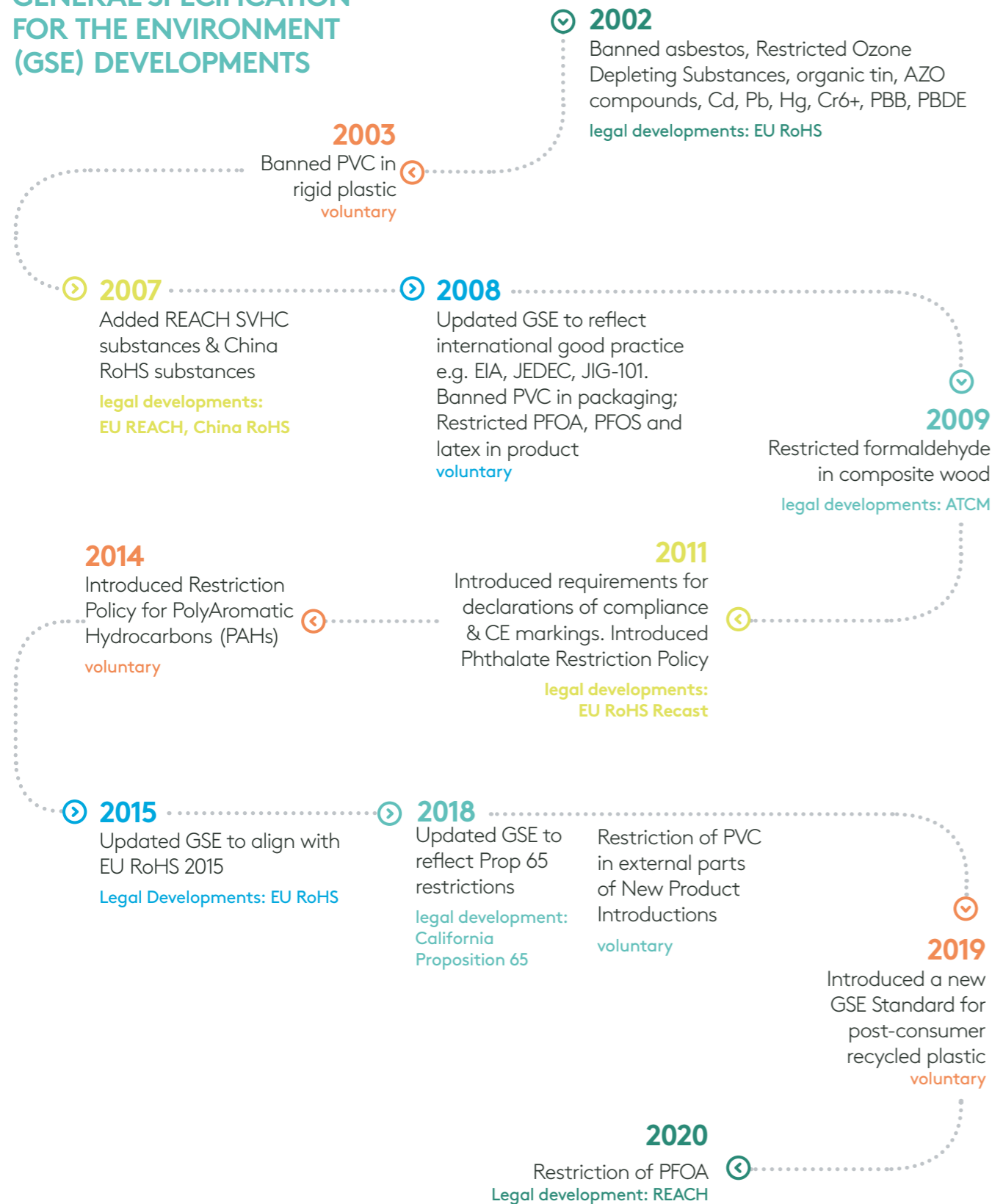

Testing & Auditing Standards

We have an established and systematic testing program, which includes sampling of Logitech products, components and manufacturing consumables on a regular basis to check and verify compliance with GSE requirements.

The scope of our testing program includes products, components and consumables produced at our own production facility and supplier manufacturing facilities.

Products and components are mechanically disjointed to the homogeneous level and tested in accordance with good laboratory

practice methods, including X-Ray Fluorescence (XRF) and Laboratory-based Chemical Analysis. Our approach allows us to demonstrate and declare single component traceability, full legal compliance and test reports for the homogeneous level, where appropriate.

In addition, we carry out periodic surveys of our suppliers to interrogate material use where pertinent e.g. when significant changes to the SVHC list for REACH are introduced.

We have a robust supplier audit program, which includes auditing of supplier facilities to

check compliance with RBA Code requirements for materials management, compliance with hazmat legislation, and compliance with our green procurement standards. Both our product testing program, and supplier factory auditing program, include a corrective action reporting and remedy process aligned with RBA good practice requirements.

73%

REDUCTION IN TARGETED SUBSTANCES SINCE CY10

Targeted Substances

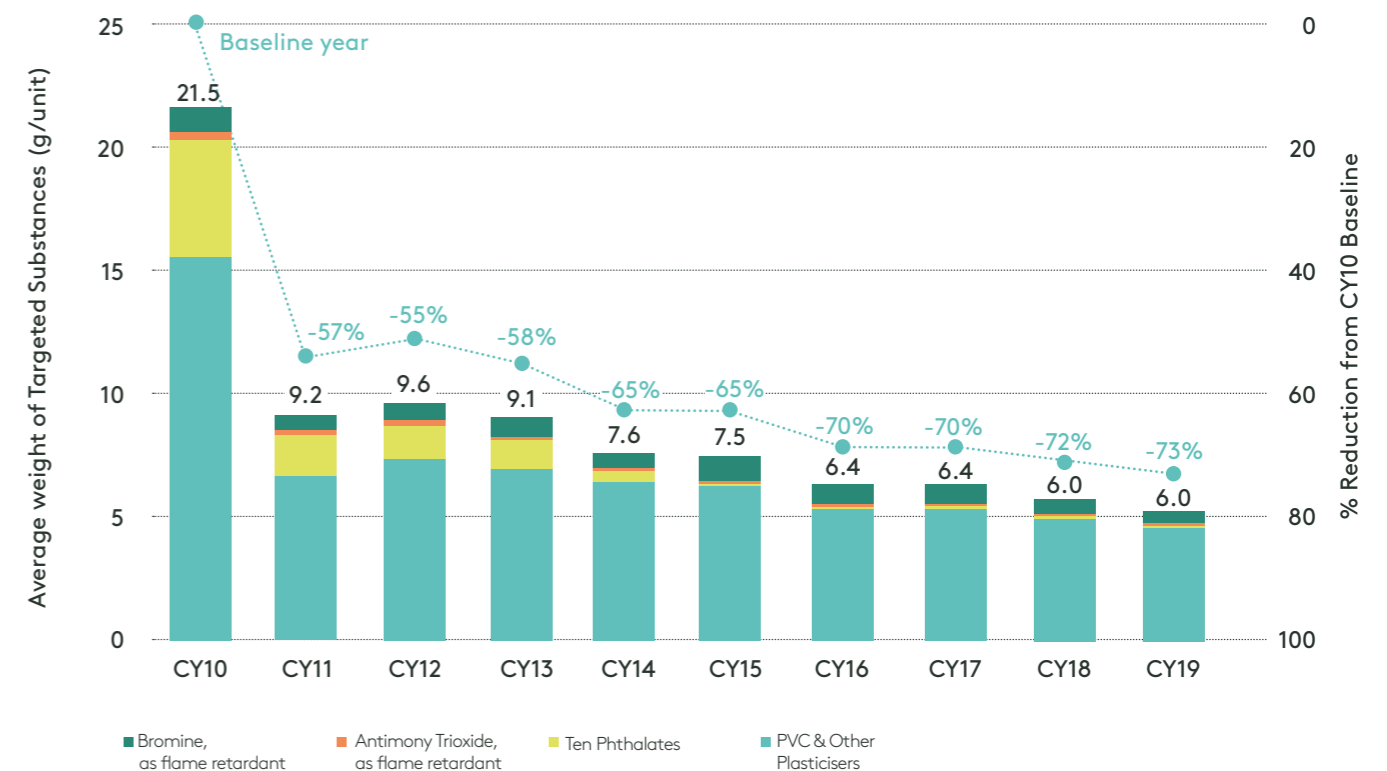

Avoiding Targeted Substances

continued

Where safer and less toxic alternatives are available, we drive voluntary phase-out of certain Targeted Substances of concern including, PVC, phthalates and associated flame retardants. These substances are widely used in our sector but they have a toxic life cycle and can contribute to adverse impacts on the environment, recycling and occupational health, during manufacture, processing and end-of-life.

As a result of these policies and program, we have substantially reduced our use of Targeted Substances year-on-year, through systematic testing of product samples, corrective actions processes and follow-

up collaboration with suppliers. The following graph shows the total weight of Targeted Substances in our top 50 retail products (units sold in FY20). As shown in the graph, the average total weight of Targeted Substances per unit has now reduced to 6g/unit, which is a 73% reduction of CY10 levels.

PVC-Free Program

Our goal is to transition to Zero PVC. In 2003, we made a voluntary commitment to phase out the use of PVC in rigid plastic. This was followed by a ban on PVC in packaging in 2008. Last year, we expanded the scope of our program, to include all feasible external parts

of new product introductions e.g. cables, adaptors, chargers and we disclosed our [PVC-Free Policy](#) on logitech.com. Our Astro, Jaybird and Ultimate Ears products are all PVC-free at this stage and in CY19 we eliminated 131t of PVC from cables and other devices, with the introduction of Thermoplastic polyurethane (TPU), a lower-toxicity alternative to PVC. We are proud of our achievements to date, but we also know there is a lot more work to do. With our expanded PVC-Free program, we are targeting new product introductions and we remain committed towards our ambition of Zero PVC by 2030.

PVC Elimination

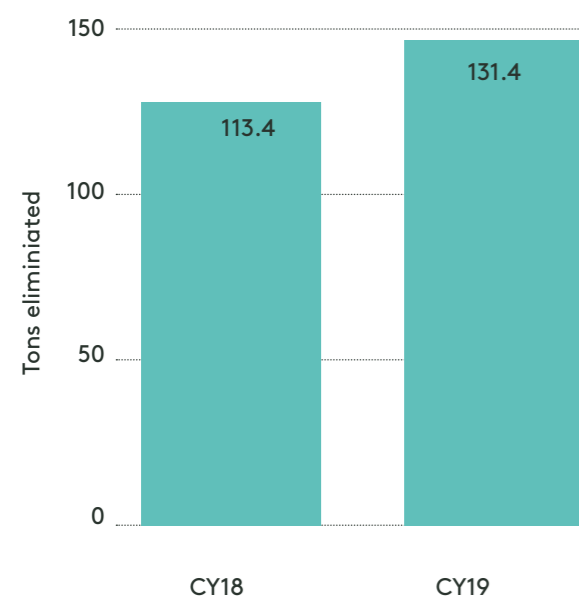

131t
OF PVC ELIMINATED
IN CY19

Zero PVC
GOAL FOR 2030

END-OF-LIFE RECYCLING

Our goal is to empower consumers to recycle in their local area. We want to work in partnership with others, to develop circular supply chains, and give end of life devices and materials a second life.

E-waste is one of the fastest growing waste streams in the world. Each year, the world produces nearly 45 million tons of e-waste and that figure is predicted to increase to nearly 54 million by 2025.

Worldwide, recycling rates continue to be low. When developing strategies to empower and enable local recycling, we consider:

- **Collection rates:** the extent to which end-of-life devices are segregated from household waste and collected by recyclers for local recycling; and
- **Recovery rates:** the extent to which components and materials can be recovered, from collected devices.

To increase collection rates, we support and finance the development of recycling infrastructure and capability in major markets. As a Responsible

Producer, we monitor evolving recycling laws, identify Producer Responsibility Organizations (PROs) and provide financial support to enable and support the development of local recycling infrastructure and capability. In CY19, we were delighted to achieve our 2020 PRO Recycling Goal of directly financing the recycling of more than 50,000 tons of electrical devices, batteries and packaging, since CY10.

In FY20, we established our global Recycling Standard, which defines our requirements for management and recycling of end of life devices and batteries. This standard is now embedded, as a contractual requirement, in the contracts of all our PRO Recycling Partners. With the introduction of this standard, we can now interrogate and better understand the final fate of

end-of-life devices and materials, which are gathered by PRO Recycling Partners, on our behalf.

In countries where we cannot finance recycling directly with our PRO Recycling Partners, we work to improve collection rates, by enforcing good practice recycling, as a contractual requirement, for our in-country business partners. Our goal is to enable and empower consumers to recycle end of life devices in their local area and avoid the carbon impact of transporting devices over long distances. We work with our business customers, including distributors, retailers and e-tailers, to enable consumer recycling in this way.

50,000 t+
FINANCED RECYCLING

¹ Bureau of International Recycling and United Nations University

End-of-Life Recycling
continued

logitech® vs. e-waste

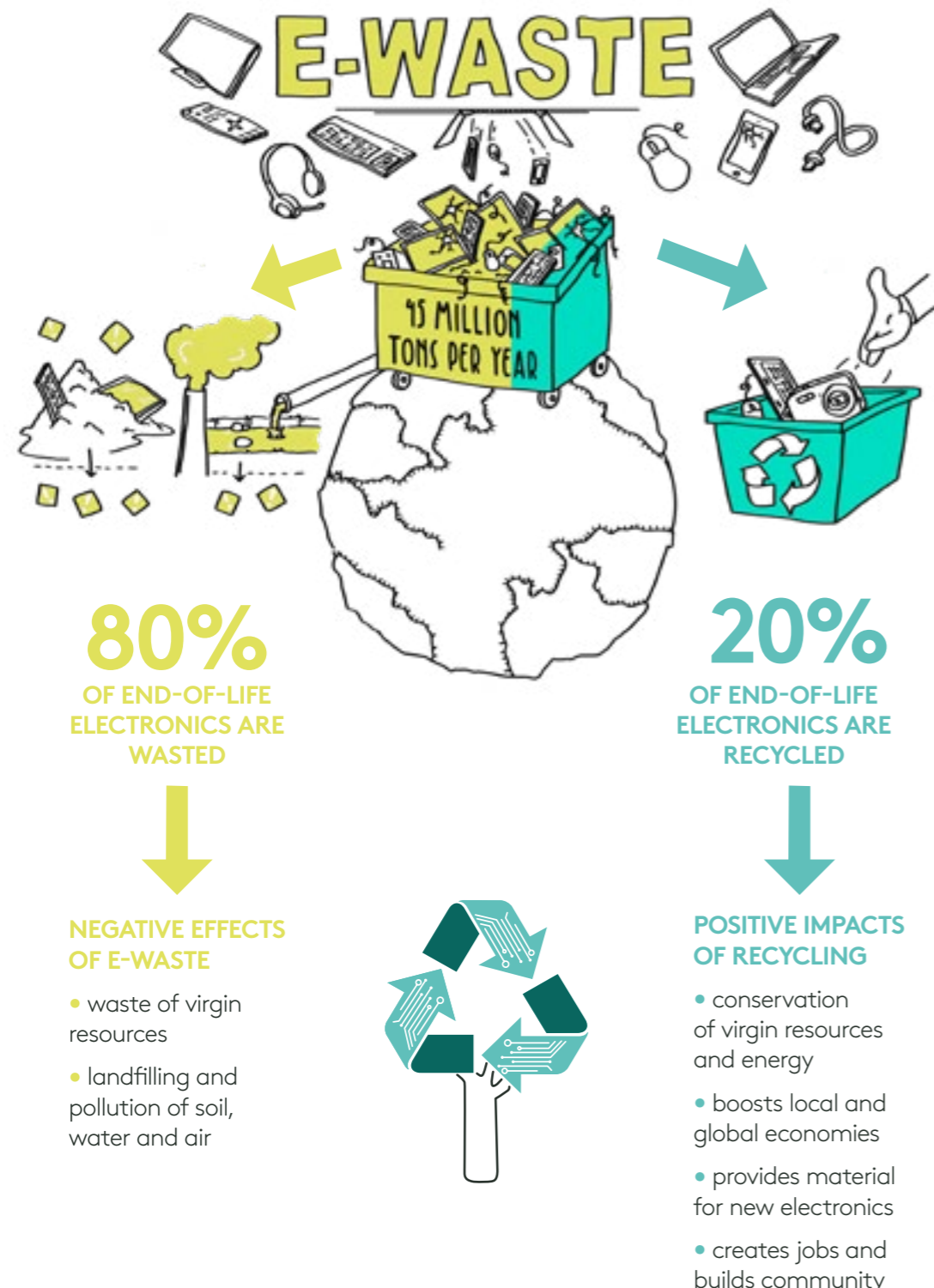

In addition to building in-country recycling capability, we recognize the need to raise consumer awareness. Batteries and electronics should not be disposed of with household waste to landfill, but this continues to occur widely in many countries across the globe. Our financing of PRO schemes includes contributions to consumer campaigns to raise awareness in major markets and in CY18, we chose to launch our own [recycling page](#) on logitech.com. The following infographic forms part of a recycling video we use on our recycling page on logitech.com, to raise awareness around the need for end-of-life recycling. We continue to expand the information we provide to consumers via that page, with the goal of providing information for every major market, in the next year.

As a product design company, we also recognize the need to design for recyclability, to enable recovery of components and materials, from end of life devices. We accept responsibility for carbon and environmental impacts associated with our choice of materials and the end-of-life phase of the product life cycle. To eliminate end-of-life contaminants of the recycling stream, we manage RoHS substances and eliminate Targeted Substances (including PVC in packaging and rigid plastics). For more information on this aspect of our approach, please refer to the [Avoiding Targeted Substances](#) section of this report.

Our longer-term goal is to design products to enable optimal use of recycled materials, end-of-life recyclability and broader circularity. Over the last

year, we have evolved our understanding of the recyclability of materials and the maturity of recycling infrastructure, and recycling capability, in major markets worldwide. These insights are informing our approach to life cycle analysis (LCA) and the development of design guidelines for both hardware and packaging. We are also implementing environmental-friendly technologies and solutions, including Post-Consumer-Recycled (PCR) plastic. For more information on this aspect of our approach, please refer to the [Design for Sustainability \(DfS\)](#) section for more information in this regard.

PRO Recycling Partners



End-of-Life Recycling

continued

RECYCLING FINANCED SINCE CY10



30,992
tons of electrical devices

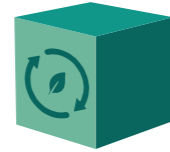

16,993
tons of packaging



2,797
tons of batteries

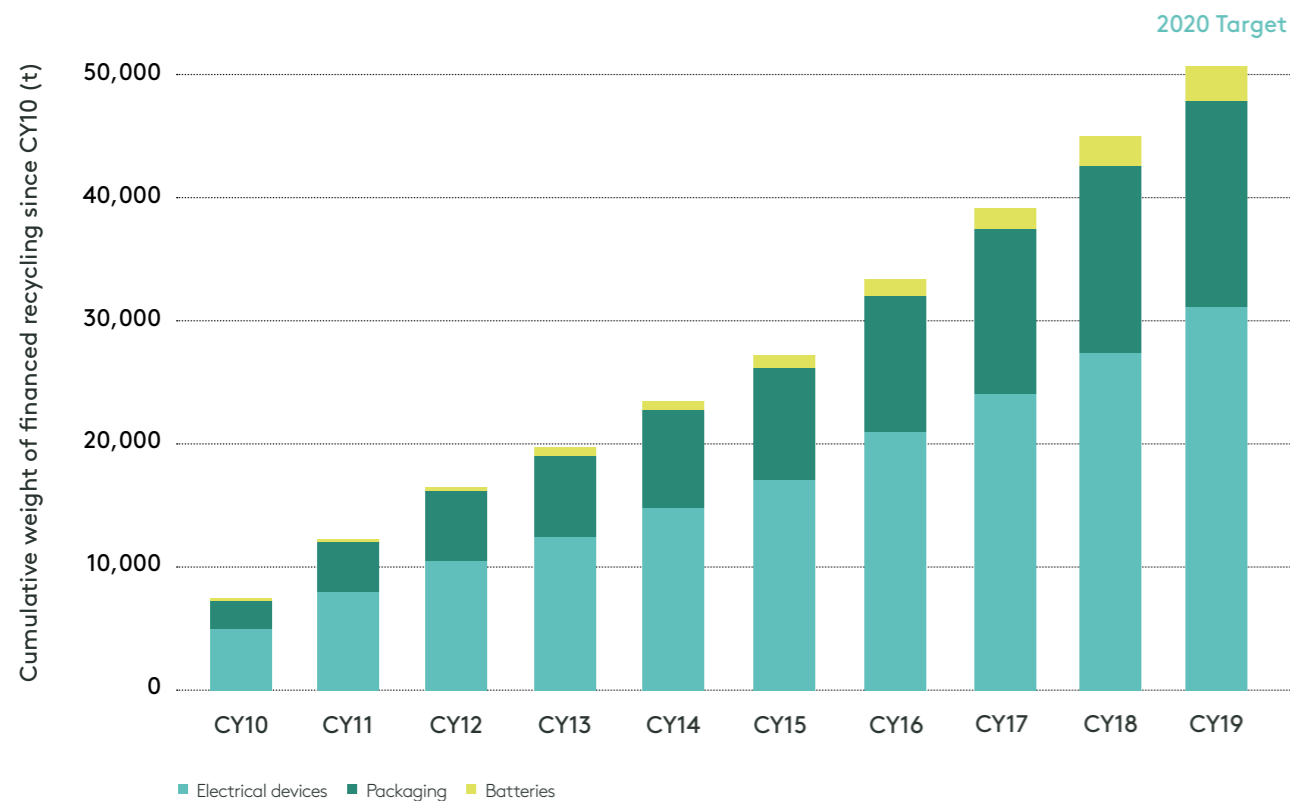

RESPONSIBLE MANUFACTURING

Logitech designs, manufactures and markets products that have an everyday place in people’s lives and connect people to the digital experiences that they care about. We are constantly challenging ourselves to take out waste and non-value added steps.

We generate a significant portion of our revenue from the products we produce in our own factory. We provide direct employment opportunities to more than 3,200 direct employees at our production facility.

Our manufacturing capacity is supported and supplemented by a supply chain of contract manufacturers, joint design manufacturers and component manufacturers, which provide additional employment opportunities across the globe.

This section provides an overview of key environmental programs and initiatives associated with our production facility. Further information on other aspects of our sustainability performance is provided in the **Safety, Health and Welfare** section and **Human Rights and Labor** section of this report.

Our governance framework for responsible manufacturing is founded on our commitment

to comply with all relevant legal requirements, the Responsible Business Alliance (RBA) Code of Conduct, International Organization for Standardization (ISO) 14001 and 45001.

We first achieved ISO 14001 and OHSAS 18001 certification of our production facility in 1999 and 2004 and we achieved ISO 45001 in July 2020.

Since that time, a team of third-party auditors have carried out annual reviews year-on-year to ensure our management system, activities and approach continue to align with international good practice and to drive continuous improvement.

Our production facility is subject to the RBA’s Validated Audit Process (VAP) and is VAP-rated green, indicating high levels of sustainability performance, and low sustainability risk.

We have more than 30 years of manufacturing experience, and we are constantly challenging

3,454

EMPLOYEES AT OUR FACTORY

ISO 14001

SINCE 1999

OHSAS 18001

SINCE 2004

ISO 45001

SINCE 2020

Responsible Manufacturing

continued

ourselves to eliminate waste and non-value added steps. We are continuously looking for ways to use new technology to create better products, reduce manual labor, improve the workplace and make manufacturing more productive and sustainable for the long-term.

With this goal in mind, we continue to introduce automation and robotic technology at our production facility, to deliver accurate, time-saving and waste-eliminating production of some of our most popular products.

The introduction of automation enables real-time adjustments for optimal efficiency and is helping us to shift worker responsibilities

from low-skilled manual labor to monitoring, calibrating and maintaining equipment, with associated soft skills.

Water and Wastewater

Approximately 95% of the water that is used at our production facility is obtained from public mains supply via a connection provided by the local authorities.

Our in-house production activities are not water-intensive; we are primarily involved in final assembly and testing. The water that we use at our facility is primarily used for drinking water, catering, showers, washrooms and other sanitary facilities

We have monitored water consumption on a monthly basis since CY10. Summary



35+

YEARS IN-HOUSE MANUFACTURING EXPERIENCE

results are shown in the following chart. As a general trend, consumption levels tend to be indirectly linked to production activities. When on-site production increases, the size of our workforce increases, leading to increased demand for drinking water and use of sanitary facilities.

A small amount of the hot water for our heating system is sourced from a nearby third-party facility, where it is produced as a by-product wastewater. This approach helps us reduce the energy demand and environmental footprint of both our own facility and the neighboring facility.

Wastewater emissions are largely limited to sanitary wastewater, which is discharged via the local authority network, in accordance with all relevant conditions of our environmental permit.

As indicated above, water is not a material issue of environmental concern for us. Our water is sourced from public mains (low risk), is not used for production (low volume) and is used primarily for welfare facilities (high priority).

As a result, the potential for significant impacts on the environment due to water-use at our production facility is low and the scale of opportunity associated with water-saving initiatives is small. We have not therefore established reduction targets for water, as we have for Greenhouse Gases (GHGs), but our commitment to lean manufacturing drives ongoing efforts to identify water-saving initiatives of benefit to the environment and our workforce.

Those initiatives typically relate to control systems for toilets and preventative maintenance

procedures to avoid water leaks and repair any leaks that do occur. In FY20, we replaced a number of valves and water pipes to reduce water loss. We also installed additional systems to enable convenient monitoring, tracking and reporting of water use in our plant and dormitory. Our internal audit programs include regular checks and monitoring to ensure the welfare facilities we provide align with good practice expectations and provide fair working conditions for workers. Additional performance data for water and wastewater are provided in the **Data** section of this report.

For more information on water use and environmental impacts in our supply chain, please refer to the **Supplier Development** section of this report.

Water use

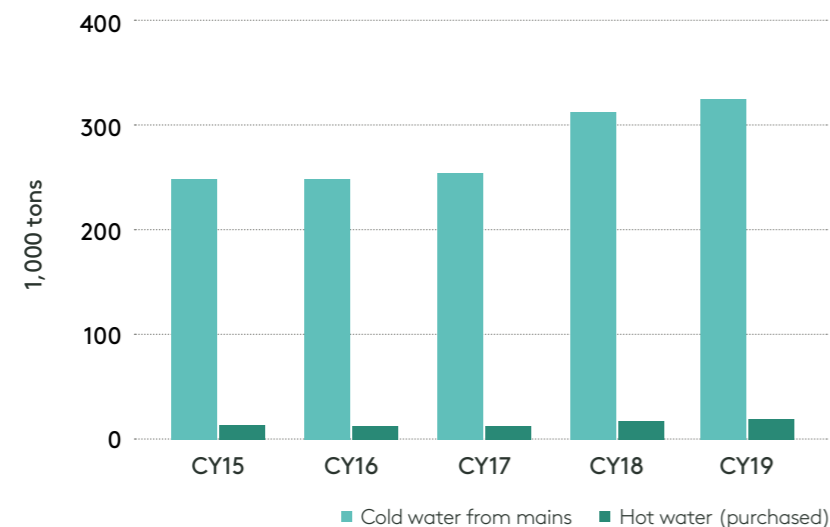

Responsible Manufacturing

continued

Hazardous Materials

Our use of hazardous materials is limited to the use of small quantities of consumables, which are necessary for final assembly activities (e.g. lubricant oils, glue, cleaning solvent).

Hazardous materials are managed in accordance with RBA Code of Conduct requirements and legal requirements. Any materials that may pose a risk to human health or the environment are identified and managed in a manner that ensures their safe handling, movement, storage, use, recycling or reuse and disposal. Safety Data Sheets (SDSs) are maintained and communicated on notice boards in employee areas and are checked by our auditors when auditing compliance with the RBA Code of Conduct.

We also have a corporate standard establishing our expectations for environmental good practices and appropriate management of workplace emissions and air quality. We have not had any incidents relating to our use of hazardous materials, and, in light of the nature and scale of materials used, incidents are not likely to occur.

Waste

Waste from our production facility is limited to food waste, paper, waste packaging (paper/cardboard and timber), Printed Circuit Boards (PCBs) and small quantities of other waste (oils, solvent, light bulbs, etc.). A full inventory is provided in the **Data** section of this report.

We follow the Waste Hierarchy i.e. we avoid the production of waste where possible and encourage reuse, recycling and other recovery options over disposal. The weight of waste arising over the course of the year is monitored and subject to internal reporting.

Hazardous waste is collected by licensed contractors and transported to licensed waste management facilities. The licenses of those contractors are checked by a dedicated team of environmental specialists who also check samples of waste consignments.

We track and report the end of life treatment pathway for all waste streams arising at our facility and visit recycling and disposal sites, where necessary to verify end-of-life treatment.

Our global footprint and supply chain extends across all boundaries and borders. With reach comes responsibility.

Prakash Arunkundrum,
Head of Global Operations

CLIMATE ACTION

Climate change caused by human activity is one of the biggest challenges of our generation. The scale of change that is needed, demands collective action. We recognize the need for big business to step up and help to lead the way.

OUR STRATEGY

In November 2019, we joined the Science-Based Targets Initiative and committed to support the Paris Agreement and developing science-based carbon reduction targets to deliver our ambitious 1.5°C climate pledge. To deliver on this pledge, we adopt a **science-based** approach and a Reduce-Renew-Restore strategy, which reflects a best practice hierarchy of climate action:

Reduce: Design for Sustainability (DfS) to achieve ambitious carbon reductions in our products, operations and supply chain

Renew: Drive ambitious uptake of renewable electricity in our own operations and supply chain. Design for renewable materials, including circular supply chains.

Restore: Restore forestry and climate-impacted communities, by financing low carbon projects

and developing nature-based solutions to capture carbon.

Our Reduce-Renew-Restore strategy is underpinned by a commitment to, and culture of, carbon transparency.

We follow good practice standards, including the Carbon Disclosure Project (CDP), The **GRI 305: Emissions (2016) Global Reporting Initiative (GRI) Standard**, Greenhouse Gas Protocol and **CarbonNeutral[®] Protocol**.

We share our carbon impact in an open and transparent way to galvanize an industry-wide shift to dramatically reduce carbon-related impacts on the environment. At this stage of the 24-month SBTi target-setting process, we are happy to share a number of the goals and targets, which we are developing to align with SBTi definitions and criteria and deliver on our 1.5°C climate pledge.

We are making a pledge to future generations that we will use our leadership in design not only to create a great customer experience but to do so in a way that is sustainable for the planet.

Bracken Darrell, President
and CEO of Logitech

Climate Action

continued

Our strategy

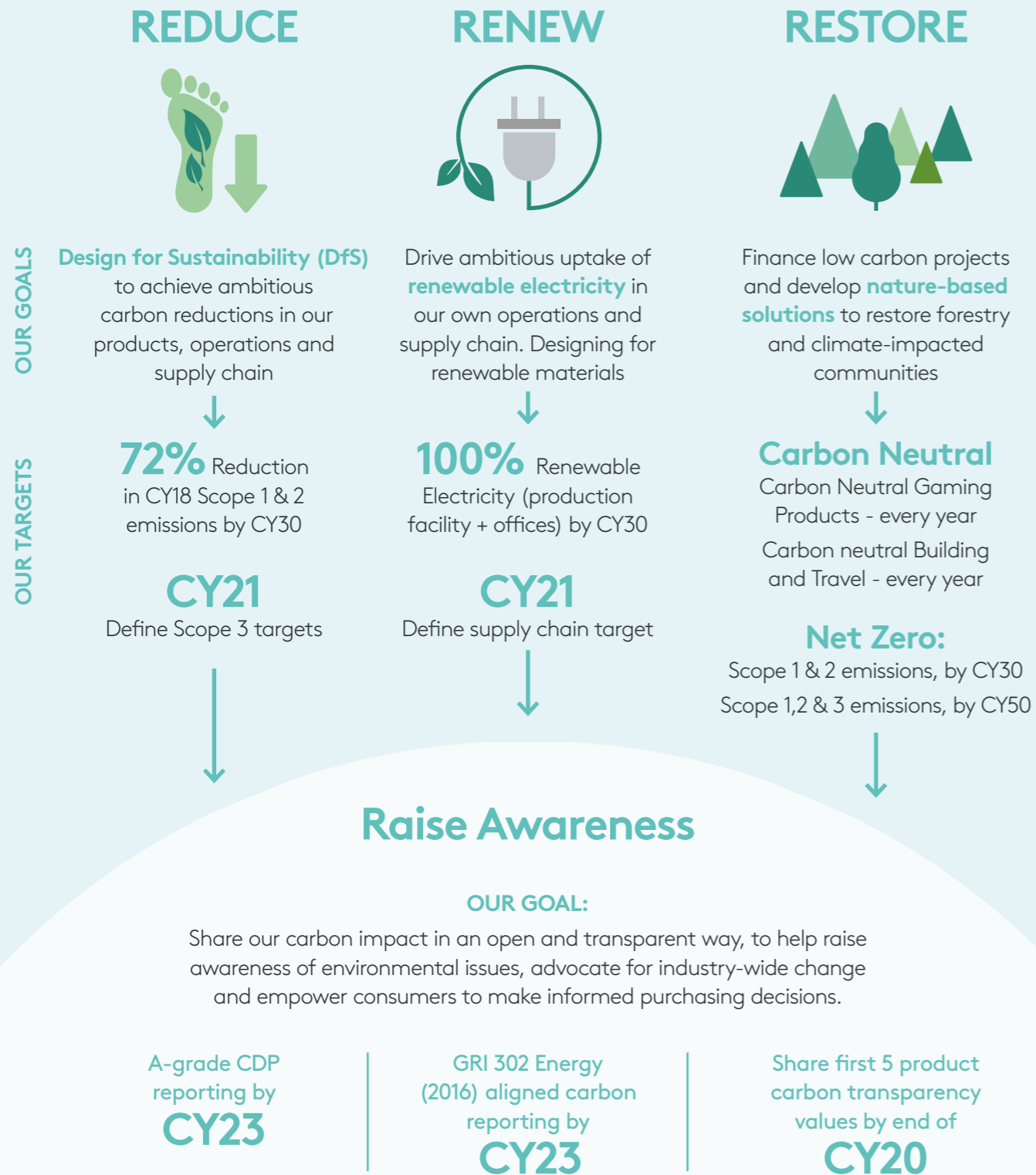

OUR PERFORMANCE

Scope 1 and 2 Emissions

In 2013 we set ourselves the target to reduce absolute Scope 1 and 2 GHG emissions at our production facility by 20% by 2018. In CY18, we achieved that target and decided to go further, to address all residual greenhouse gas emissions and achieve CarbonNeutral[®] Building certification. Carbon neutrality was achieved after a number of years of energy efficiency programs, the purchase of renewable electricity (iRECs¹) to renew our electricity footprint, and financing of carbon avoidance projects to offset residual emissions, which could not be addressed by other means.

In the last year, we have continued this reduce-renew-

restore strategy with programs delivering energy efficiency, renewable electricity, and carbon neutrality. We reduced absolute energy demand with our LED program (replacing conventional T5 lighting with LED), while optimizing our use of air compressors and installing time controllers to power-down lighting and turn off drinking water fountains. We also continued to develop our metering program, to help us track and understand hotspots of energy use, where reduction opportunities can be identified. With those efforts, we saved an estimated 390,000 kWh of energy, which equates to 248tCO₂e. We continued to balance our electricity footprint with the purchase of 100% renewable electricity to achieve RE100 and we maintained our carbon neutral certification.

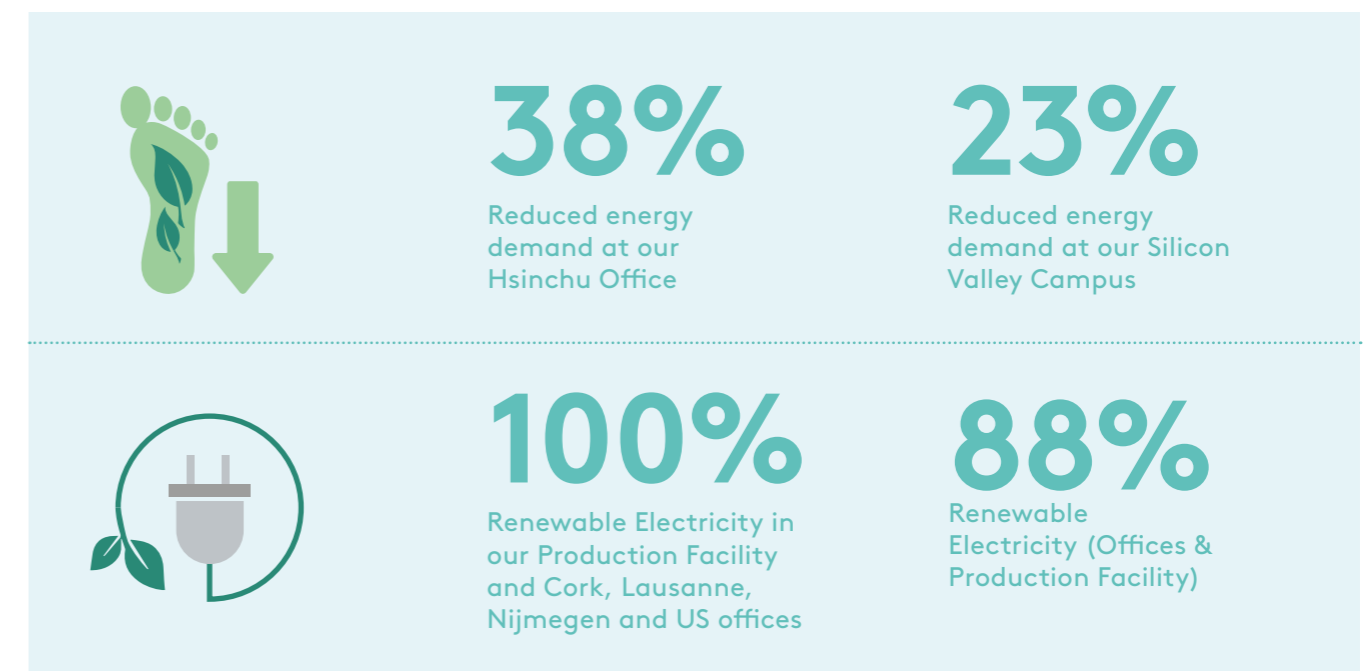

1 iRECs are International Renewable Energy Certificates purchased to balance a company's electricity footprint (Scope 2 emissions)

Climate Action

continued

In the last year, we have also consolidated our greenhouse gas inventory for our offices. Our network of global offices includes 24 Principal Offices (i.e. offices with more than 20 occupants) and a number of smaller (sales-focused) offices worldwide. All of our offices but one, are leased premises and many of our office spaces are in shared or third-party buildings, but we chose to treat their carbon footprint as our own, and include it in our Scope 1 and 2 inventory. Where possible, and in collaboration with local landlords, we implement energy efficiency and carbon reduction programs. For example, over the last five years, our LED lighting program for our Hsinchu office has helped us reduce energy demand by 38% (CY19 compared to CY15). This year, we

modified the HVAC system in our Silicon Valley Campus to respond to varying levels of occupancy at different times of the day and weekend and this allowed us to reduce total energy demand in CY19 by 23%, compared to CY18.

88% of our global electricity footprint is now renewable. We commit to achieving RE100 (100% renewable electricity) by 2030 and we are working with the RE100 membership to enable access to renewable electricity in countries where it is not currently available. For further data and key performance indicators, please refer to the [Data](#) section of this report.

In addition to the above, this year we started on our [journey to net zero](#). To address residual Scope 1 emissions (from our production facility and offices),

which cannot be tackled this year by reduction or renewal programs, we are now investing in carbon sequestration projects, to offset our impact. We follow a strict hierarchy of climate action - we only purchase offsets, as a bridge to a better solution - something that we do right now because it's possible right now - while we develop capability (along with the rest of the world) to design for sustainability and transition to low-carbon alternatives. With our offsetting investments to address Scope 1 emissions, we prioritize forestry and livelihood projects, to help restore climate-impacted communities. For more information on the full suite of offset projects we support, please visit our newly launched [Climate Action Webpage](#) on logitech.com.

Pathway to 1.5 Degree Target and Net Zero

Scope 1 & 2

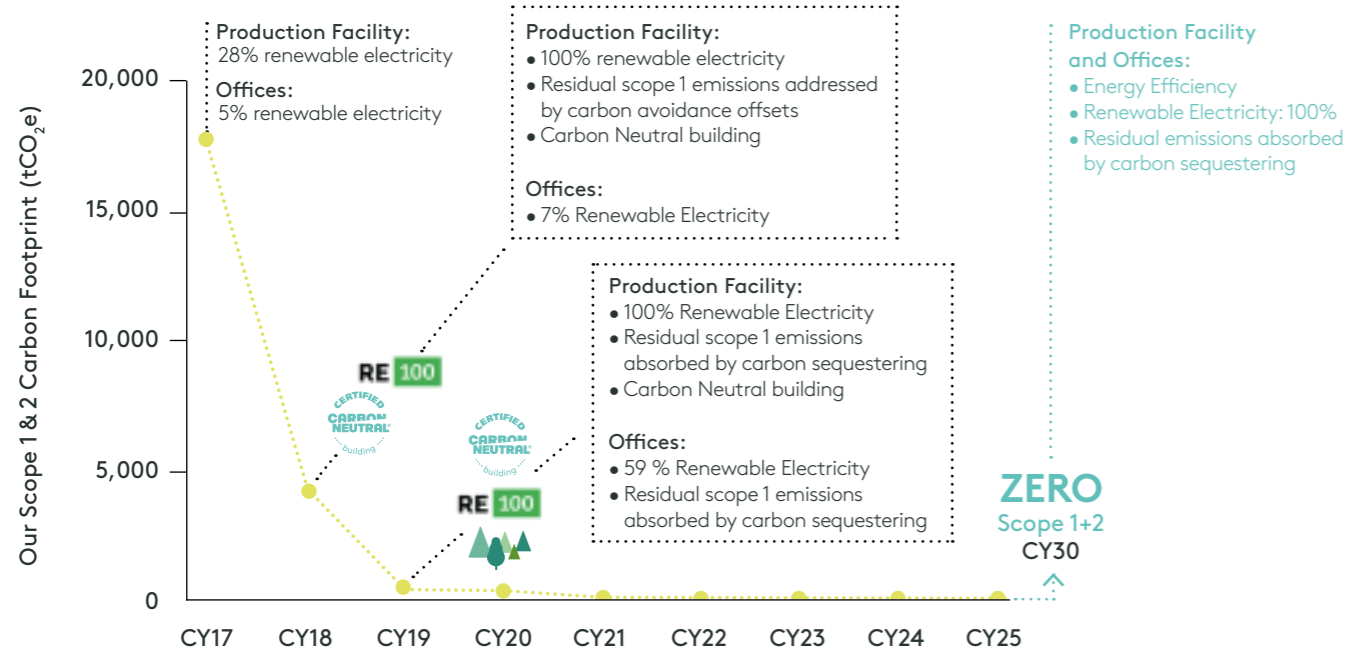

Scope 3 Emissions

This year and for the first time, we have completed a mapping and materiality assessment of our full corporate carbon footprint, including Scope 3 emissions. Our estimated Scope 3 inventory is presented in full, in the Data section of this report. In the remainder of this section, we have focused on the four categories of our footprint, which are material and provided an overview of our calculation methodology and current estimations. For scope 3 targeted, we are following the SBTi target-setting schedule and commit to announcing these targets as part of our next reporting cycle.

Purchased Goods and Services (Category 1)

Category 1 (Purchased Goods and Services) is the largest segment of our corporate carbon footprint. We currently estimate it accounts for 73% of our total footprint. The footprint of this category includes all upstream greenhouse gas emissions associated with sourcing, transportation and third-party manufacture of raw materials, parts and components, for Logitech products. We estimate this segment of our footprint by surveying our Tier 1 Major Suppliers (to understand Tier 1 supplier manufacturing emissions) and by Life-Cycle Analysis studies of Logitech

products (to estimate upstream manufacturing emissions).

We launched our annual Supplier Carbon & Climate Survey in 2018, to capture CY17 carbon data. Our goal was to survey 80% of our Tier 1 suppliers, by spend. Since 2018, our survey scope and supplier response rate has increased year-on-year, as we have provided more guidance and training and encouraged suppliers to participate and respond. This year, we achieved our targets for survey scope, response rate and data accuracy. This year, we are inviting suppliers to join with us, to purchase renewable electricity and address their Scope 2 emissions and we are launching a Logitech-sponsored, Renewable Electricity Platform to catalyze purchase of third-party certified renewable electricity for supplier factories engaged in Logitech manufacturing.

To estimate the carbon footprint of upstream materials and manufacturers beyond our Tier 1 Major Suppliers, we use LCA modeling. We have completed internal LCA studies of representative products, across 24% of our Major Product Lines², using the Umberto^(R) software platform, with Ecoinvent and GaBI datasets. We use assumptions to extrapolate insights and estimates for these products, to estimate the footprint of our entire portfolio. We expect to refine our

estimates, over the forthcoming number of years, as new information becomes available and we complete further LCA studies. For further information on our Design for Sustainability program and Carbon Transparency commitment, please refer to the [Design for Sustainability \(DfS\)](#) section and [Carbon Transparency](#) section of this report.

Product Use (Category 11)

According to our current estimates, Category 11 (Product Use), is the second-largest segment of our corporate carbon footprint, accounting for approximately 11% of our total Scope 3 footprint in CY19. This segment of our footprint is also currently estimated by LCA modeling, as described above. As we continue to evolve our methodology for calculating this category of our carbon footprint and complete further LCA studies, we expect to refine our estimate of this segment of our footprint, over the next number of years. We will also be adding the estimated carbon footprint of our software products, which have not yet been considered as part of the work to date.

End of Life (Category 12)

This category captures the carbon footprint associated with end-of-life treatment of Logitech products, batteries and packaging. We currently

² Major Product Lines: Product Lines accounting for more than 80% of shipments, by weight, in the previous Calendar Year

Case Study

Our Production Facility Certified CarbonNeutral[®]

This year, we continued to balance our electricity footprint with purchase of 100% renewable electricity and we maintained our carbon neutral certification. We have also started our journey to net zero. To address residual Scope 1 emissions, which cannot be tackled this year by reduction or renewal programs, we have invested in carbon sequestration projects (forestry), to absorb and balance our emissions.

WHAT DOES CARBONNEUTRAL[®] AND NET ZERO SCOPE 1 & 2 MEAN?

90% iRECS

iRECS are International Renewable Energy Certificates, which enable companies to buy renewable electricity in China.

10% CARBON OFFSETS

We financed carbon sequestering forestry projects, to absorb residual (Scope 1) emissions, which could not be addressed by other means this year

0 NET ZERO

THE STORY SO FAR

- 2005**
 - Established our Suzhou production facility
- 2011**
 - Started purchasing hot wastewater from a local plant, to reuse as a heat source for heating water on-site
- 2012**
 - Started reporting energy use to the Carbon Disclosure Project (CDP)
 - Set target to reduce 2010 GHG emissions by 20% by 2018
 - Upgraded chillers and compressors
- 2013**
 - Improved AC efficiency
- 2014**
 - Upgraded and replaced lighting
- 2015**
 - Introduced electric buses on-site
 - Purchase of renewable electricity (iRECS)
- 2017**
 - Third-party energy efficiency audit to identify further opportunities
 - Continued purchase of renewable energy (iRECS)
- 2018**
 - installation of large scale metering program
 - Purchase of iRECS and carbon offsets to achieve carbon neutrality
- 2019**
 - Continued LED lighting program
 - Optimized use of air compressors
 - Installed time controllers on lights and water fountains
 - Continued purchase of renewable electricity (iRECS)



0
Residual emissions sequestered to achieve net zero Scope 1 and 2

100%
Renewable electricity at our Production Facility

Manufacturing emissions neutralised each year
15,000
tCO₂e

6%
Reduction in electricity demand

estimate it accounts for approximately 6% of our corporate carbon footprint. To generate that estimate, we reviewed our global sales network and the maturity and current status of recycling laws, infrastructure, technology and capability in our Major Countries of Sale³. We assumed the worst-case scenario in many areas, recognizing the challenges associated with the recycling of small consumer electronics. As noted in the **End-of-life Recycling** section of this report, we will be tackling this aspect of our footprint with strategies to increase collection and recovery rates and as noted in the **Design for Sustainability (DfS)** section, we are also developing tools and strategies to help product teams optimize product recyclability and circularity.

Transportation & Distribution (Category 4)

Our supply chain to market is complex. Logitech products are sold to almost every country in the world via a network of trusted partners. Over the last two years, we have been working with the Smart Freight Centre (SFC), to develop a tool to collect, capture, and report the carbon footprint of our global distribution network. We call this tool the Logitech Logistics Carbon Calculator (LogiLoCC). The LogiLoCC has

developed to reflect the GLEC Framework⁴. In January 2020, the SFC finalized third-party certification of the LogiLoCC tool and our associated methodology and assumptions. From the information we have gathered for CY19, we understand the carbon impact of transportation and distribution (category 4) accounts for approximately 4% of our total footprint. Now that we have established our baseline, and a mechanism for ongoing tracking of this segment of our footprint, we are turning our attention to the development of reduction targets and a reduction pathway.

All Other Categories

Our full Scope 3 inventory is presented in the Data section of this report. In this section, we have focused on the categories that are material. All other categories of our footprint are not applicable (e.g. Category 8, 10, 13, 14 and 15) or they account for less than 2% of our total footprint and are not considered to be material (e.g. Category 2, 3, 6, 7 and 9.)

Our climate action strategy will therefore continue to develop to target and focus on Scope 1 and 2 emissions (our biggest and direct responsibility) and the four Scope 3 categories listed above (our biggest opportunities).

We want to leave our mark on the future. We know that mark can be positive or negative, depending on the large and small decisions we make every day.

Bracken Darrell, President and CEO of Logitech

⁴ The Global Logistics Emissions Council (GLEC) Framework: a globally-recognized methodology and good practice standard for harmonized calculation and reporting of greenhouse gas emissions across a multi-modal supply chain. The GLEC Framework is fully aligned with the Greenhouse Gas Protocol, UN-led Global Green Freight Action Plan and Carbon Disclosure Project (CDP) reporting standards.

Climate Action continued



73%

SOURCING & MANUFACTURE

OIL
(Plastic parts & packaging)

METAL
(PCBs, Batteries, components)

TREES
(Paper packaging)

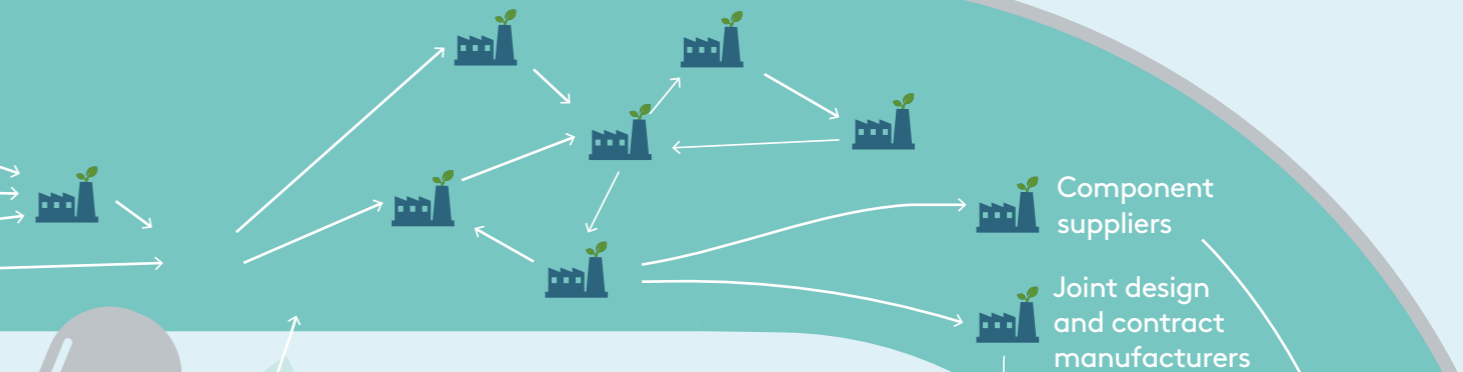

Component suppliers

Joint design and contract manufacturers

OUR CORPORATE CARBON FOOTPRINT

END OF LIFE

6%

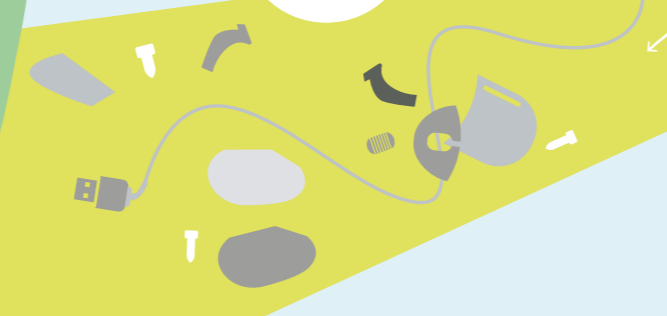

END USER

CONSUMER USE

11%



DISTRIBUTION

6%



OUR OFFICES

4%

OTHER

TRANSPORTATION & DISTRIBUTION

CARBON TRANSPARENCY

We are aware of the urgent need to take climate action. By being open and transparent about our impact, we believe we can drive better design decisions in our own teams and more informed purchasing decisions amongst consumers.

Carbon footprinting is one way to measure and quantify a product's complex impact on the environment. From the weight of plastics to the size of the printed circuit boards, to the recycled content, to the end of life recycling - carbon footprinting helps us to quantify environmental impacts and informs our design decisions.

We have developed our Life Cycle Analysis (LCA) capability so that we can quantify the carbon footprint of our products across their full life-cycle, from sourcing of raw materials, through to manufacturing, distribution, consumer use and product end of life. Data sources and methodologies for capturing the full complexity of environmental impacts continue to evolve year-on-year. We continue to invest time and resources to ensure we're at the forefront of innovation in this space.

This year, we became the first consumer electronics company

to commit to providing carbon impact labels on product packaging across our portfolio. We will start to apply Carbon Transparency labels to our gaming products later this year and we have made the commitment to label all of our products by 2025. With the introduction of our Carbon Transparency label, we will provide a product carbon footprint value on the product package, as well as additional insight and information for consumers and partners on our [Carbon Transparency webpage](#). Our Carbon Transparency labels will help consumers evaluate products, not only in terms of price and technical features, but also with an understanding of the environmental impact a product can have. We are inviting other companies to join us in driving positive change by providing full transparency on their products. It will take an industry-wide effort to truly make a difference.

CARBON TRANSPARENCY

TO DEKRA CERTIFICATION STANDARDS AND ISO 14067 AND ISO 14026

By communicating our carbon impact we are empowering and collaborating with our consumers to better the world. Carbon is the new calorie - we need to know what we're consuming.

Bracken Darrell, president and CEO of Logitech



1 Denotes the product carbon footprint of the full lifecycle of the product, from materials sourcing and manufacture, distribution, consumer use, and end of life.

2 The product carbon footprint has been verifiably offset, thereby rendering it Carbon Neutral.

Note: The carbon value shown here is for illustration purposes only

To support the integrity of carbon calculations, we are working with iPoint Group and an independent verifier to critically verify and validate product-level carbon impacts to DEKRA certification standards. We will communicate both the product carbon footprint (on the box) and also the calculation methodology and protocol applied, to meet

ISO 14067 and ISO 14026 best practice standards.

When we calculate the carbon impact of a product, we may also purchase offsets, to address the calculated footprint and deliver carbon neutrality. The insights generated by this program are key to understanding the environmental hotspots of our current portfolio of products.

These hotspots will, in turn, guide the focus of our innovations around materials, processes and technologies, helping to ensure that successive generations of products are designed to have lower environmental footprints. For more information, please visit: www.logitech.com/sustainability/carbon-transparency.html

PEOPLE AND SOCIETY

ETHICS

We look to exemplify integrity in everything we do. We help employees and business partners understand our ethical obligations and reinforce the positive behaviors that make Logitech a great place to work.

As a company publicly offering securities in the US and Switzerland, we comply with the laws and rules of the US Security Exchange Commission (SEC) (the Securities Act of 1933, Securities Exchange Act of 1934 and the Sarbanes-Oxley Act of 2002), as well as the laws and rules governing the SIX Swiss Exchange. As RBA members, we commit to upholding the highest standards of integrity in our own business and in all business interactions with zero-tolerance for any and all forms of bribery, corruption, extortion and embezzlement.

Leadership

Our Leadership Team (including Management Team and Board Directors) can be viewed on our website [here](#). We have four board-level committees (Audit, Compensation, Nominating and Technology and Innovation) and the charters for these committees can be found [here](#). Every member of the Board of Directors is required to sign and acknowledge our Code of Conduct.

In addition, the Company's General Counsel, Chief Financial Officer, Chief Compliance Officer, and Heads of Internal Audit and People & Culture all meet regularly and review compliance-related issues and communications, and each of them regularly report directly to the board-level Audit Committee on compliance-related topics.

We also undertake an Annual Risk Assessment, which takes into account country-level risks, and risks associated with various functional responsibilities across Logitech. The risk assessment process is facilitated by our Internal Audit team and informs the development of an Annual Audit Plan for operational audits and Sarbanes-Oxley (SOX) Assessments. The results of the risk assessment are incorporated in an Annual Audit Plan, which is reviewed and approved by the Board-Level Audit Committee.

Policy Framework

The [Logitech Code of Conduct](#) is our framework for business ethics. We have tried to make it easy to read, understand



and follow. It is available in multiple languages, reflecting our geographically diverse workforce and communicated across the globe to employees, as part of induction training and periodic refresher training. Our commitment to the Logitech Code of Conduct drives us to look beyond compliance and identify, mitigate, and manage operational risks and opportunities to create reputational value.

At Logitech, we commit to a culture that instills the instinct to do the right thing. As set out in our [Anti-Corruption Policy](#), we do business the right way, meaning that we approach everything we do with ethics and integrity. There is no right way to do the wrong thing, which makes clear our Anti-Corruption Policy statement: Logitech does not tolerate corruption in any form. Neither Logitech nor anyone working for or on our behalf may give or receive any bribe, kickback or other corrupt incentive.

Compliance with the Logitech Code of Conduct and our Anti-Corruption Policy is mandatory. For employees, non-compliance may result in disciplinary action, including termination of employment.

In addition to the above, we also have our [Corporate Governance Principles](#), [Information Systems](#)

[Acceptable Use Policy](#) and [Insider Trading Policy](#), which further address more specific aspects of ethical performance.

We regularly conduct core compliance training for employees, with supplementary training on special topics (e.g., anti-corruption, antitrust, anti-harassment) for target regions and high-risk groups. We also provide additional training on a regional basis in response to employee feedback and other needs.

We actively work to identify new ideas, innovations, standards and tools for corporate compliance and ethics, and maintain oversight of the latest developments in compliance law, management, best practice and diagnostics via external resources, seminars, peer discussions and periodic benchmarking surveys. We also regularly review our ethical framework to ensure it continually improves and evolves in line with our needs and international good practice.

Political Contributions

We do not support or fund political parties, candidates or any groups that promote party interests. No political contributions were made on behalf of Logitech FY20. Our employees may offer support and contributions to political groups in a personal capacity.

Few things are as important as your reputation. That's true for companies and individuals alike. Logitech's ethical reputation is the foundation of our continued success. By following the principles and policies spelled out in our Code of Conduct, we protect both.

Bracken Darrell, president and CEO of Logitech

¹ Our definition of significance is aligned with the materiality definition applied in our mainstream annual financial reporting

Ethics

continued

Ethics Hotline

Every employee has the right and the responsibility to report any observations, concerns, grievances or issues relevant to our Code of Conduct and commitment to ethical good practice. We have an established Ethics Hotline, which is hosted by EthicsPoint. This hotline facility is a whistle-blowing mechanism, which employees

can use, to confidentially and anonymously report any issues they identify or observe. Reports to the hotline are investigated and managed in accordance with defined procedures, which are overseen by our Legal, People & Culture and Internal Audit functions. We have a no retaliation policy; the identity of individuals who may choose to report issues are protected.

Our Internal Audit team is responsible for investigating allegations that are raised as a result of internal audits and certain submissions via the Ethics Hotline. Audit findings and remediation actions are reported to the Audit Committee on a quarterly basis.

In FY20, we did not have any legal actions pending or completed for anti-competitive

behavior or violations of anti-trust or monopoly legislation. We also did not have any significant non-compliances with environmental laws and regulations.¹

Product Labeling and Marketing

100% of our Major Product Lines in CY19 were regulated by laws on Restrictions on Hazardous Substances (RoHS) and Waste Electronic and Electrical Equipment (WEEE). All relevant products were marked with the required regulatory labels and safe use information. We communicate the meaning of all our regulatory and voluntary recycling labels on our [Recycling Page](#) on logitech.com, to inform consumer understanding and awareness around the variety of different labels that we apply. In FY20, we did not have any incidents of non-compliance with regulations concerning product and service information, labeling or marketing communications (including advertising, promotion and sponsorship), resulting in a warning, fine or penalty

In the last two years, we have adopted a number of voluntary environmental labels to raise consumer awareness around the work we are doing to minimize our environmental footprint. Examples include our use of the Forest Stewardship Council^(R)

label (to indicate packaging sourced from responsibly-managed forests), the Certified Carbon Neutral Product^(R) label (to indicate where we have neutralized the carbon footprint of gaming products) and our Carbon Transparency Label (to indicate where we have calculated and neutralized the carbon footprint of products). In FY20, we did not have any incidents of non-compliance with these voluntary standards, resulting in a fine or penalty.

Suppliers and Supply Chain

We take particular care to ensure our suppliers understand our ethical commitment and requirements. The Logitech Code of Conduct and RBA Code is shared with Major Suppliers, as part of our supplier on-boarding and training and embedded as a contractual condition of doing business.²

We develop our suppliers with training and capability-building initiatives and we audit suppliers with best practice RBA auditing tools. Compliance with the Logitech Code of Conduct and our Anti-Corruption Policy is mandatory. For third parties, non-compliance may result in the termination of our business relationship. (see [Supplier Development](#) section of this report for further information).

We conduct business in a fair, honest, and transparent manner. Employing exceptional ethical standards and practices is how we work, and helps us ensure the long term interests of our stakeholders.

Ethical Framework

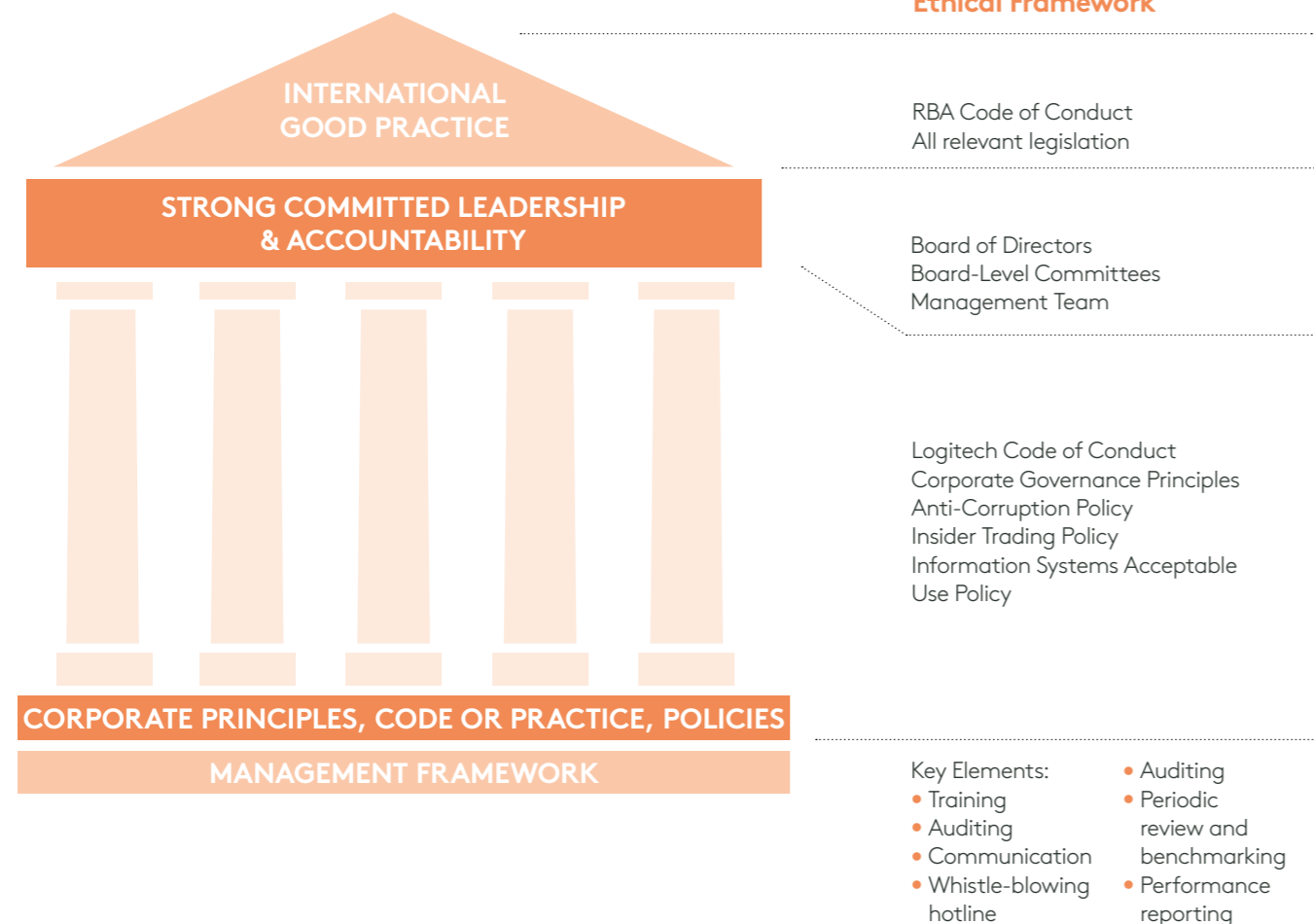

¹ Our definition of significance is aligned with the materiality definition applied in our mainstream annual financial reporting

² Major Suppliers are defined as the suppliers that account for 80% of direct spend, as per RBA requirements. See Supplier Development section, for further information

PRIVACY AND SECURITY

We respect the privacy and personal data of our employees, customers and other stakeholders. We maintain privacy and security systems and capabilities to ensure stakeholder trust when interacting with Logitech systems, products and service.

With the current trend of digitization, including cloud computing, online marketplaces and digital payments for example, we recognize increasing levels of stakeholder concern around information security, product security and privacy of user information. Maintaining stakeholder trust is of paramount importance to Logitech as we handle an increasing amount of data, within our growing software business, online sales platforms and internal infrastructure and systems.

Privacy

Since the introduction of the General Data Protection Regulation (GDPR) in 2018 we have seen increased stakeholder interest in privacy-related issues. Recognizing the importance of this topic, we have established a privacy team with a Head of Privacy that develops and operates several privacy functions including, privacy governance, privacy vendor reviews, data governance and global training and awareness. Face-to-face privacy training was recently completed in each of our principal offices,

supplemented by virtual training which was facilitated via our workforce management system. In addition to this foundational training, we have also implemented additional, focused training for specific teams (e.g. teams involved in human resources, vendor management, legal compliance or marketing). This in-person and virtual training was complemented by a number of employee communications on a newly established Privacy Page on our employee intranet. With these measures ongoing, we ensure employees are aware of the importance of privacy and security, as well as company requirements, expectations and key control measures. Our **Acceptable Use Policy** also defines privacy requirements and other controls governing access to Logitech devices.

For customers, we maintain our **Privacy Policy for Products & Services**, which outlines what types of data we collect, how we use it, and how we protect personal information collected by our products, services, apps, software and other devices. For each of our product lines, we perform privacy risk assessments that evaluate

how our products interact with our users and personal data.

We also have an established **Privacy Policy for our Website**, which outlines how we collect and use personal data from visitors to our website and mobile sites and when individuals can choose to opt-out or consent to opt-in. We are also certified participants in the EU-US and Swiss-US Privacy Shield Framework (see [here](#)) and adhere to relevant good practice governing the collection, use, and retention of personal information transferred between the European Union, Switzerland and the United States. We have provisions in place to track and report the number of substantiated complaints received in the last financial year. We received no such complaints in FY20.

Product Security

The Technology and Innovation Committee of our Board of Directors oversees our product security risk management framework. We have established the Product Security Review Board (PSRB) comprising of employees with relevant

experience and expertise. The PSRB defines the policies and practices that all of our product teams must adhere to and follows Open Web Application Security Project (OWASP(R)) good practice guidelines. We are also members of several industry standards groups focusing on product security standards.

We define a security vulnerability as an unintended weakness in a product that could allow a hacker to compromise the integrity, availability, or confidentiality of a product or service. We adopt a lifecycle approach to managing this risk. Relevant security risks are identified early in the design process, via our established risk assessment process. Appropriate security measures are developed to address any such risks and vulnerabilities, and embedded into the product design as it evolves. This may include incorporating encryption, digital signatures, multi-factor authentication, and network security as needed, based on each product's data and network access needs. We carry out full security testing, prior to product launch and the chairperson of

the PSRB has the authority to halt any new product launch if the product security standards are not met. The PSRB reviews and provides final approval on the security design for all new products under development. The decision of the PSRB Chair can only be overruled by our Chief Executive Officer (CEO).

We also welcome reports from independent researchers, industry organizations, vendors, customers, and other relevant stakeholders and sources post-launch. For this purpose, we have a public Vulnerability Disclosure and Bug Bounty Program and facilitate the receipt of such reports through our **HackerOne platform**. All submissions to this platform are reviewed by the appropriate security team members and are investigated further to determine the appropriate remedy, with an appropriate bounty paid to the relevant reporter.

We gather data on product security breaches and incidents on a regular basis and we have not experienced any breaches, incidents, fines or accrued liability in the past three years.

EMPLOYEE SAFETY, HEALTH AND WELLBEING

Our continued success is fuelled by creative, resourceful and innovative people across the globe – within Logitech, and in our supply chain. The safety, health and wellbeing of all our people is important to us.

We look to safeguard the safety, health and wellbeing of all members of the Logitech team. We want to ensure everyone feels cared for, and employees can respond safely and creatively to the fast-paced environment of our sector, and the challenges of a competitive marketplace.

Our [Corporate Global Health, Safety and Security Policy Statement](#), is a foundational policy, which applies to all elements of our business. It demonstrates the commitment of our executive management team to protecting our employees and ensuring that we are operating in compliance with legislative requirements.

We implement training and communication programs across the business each year to ensure employee awareness of the importance of health and safety management and our key programs and provisions.

Our production facility

To help us ensure the safety, health and wellbeing of employees at our production facility, we follow the RBA Code and have an integrated Environmental, Health and Safety (EHS) Management System. The management system is certified to ISO 45001. It includes an EHS Policy, as well as procedures and programs, which drive identification, assessment and evaluation of health and safety performance relative to applicable legal requirements, as well as continual improvement of our health and safety performance, in line with industry good practice, and the RBA Code of Conduct.

At our production facility, a team of internal Health and Safety Auditors audit different work areas periodically, under the direction of an established Safety Steering Committee, and ensure proactive consideration

of potential hazards, risks and control measures. Compliance with ISO 45001 and the RBA Code of Conduct is also audited annually by an independent



OHSAS 18001

SINCE 2004

ISO 45001

SINCE 2020

third-party. We have maintained OHSAS 18001 certification year-on-year since 2004, along with a “low risk” category high score in the RBA Validated Audit Process (VAP) since 2015 and we were delighted to achieve ISO 45001 certification in July 2020.

A number of health and safety initiatives were delivered during FY19 to ensure regulatory compliance, good practice and continual improvement at our production facility. Some examples include:

- employee health surveillance and third-party testing of work areas to ensure air quality conforms with occupational health standards;
- annual safety training for all contractors to understand safety hazards, high-risk contractor work and work authorization requirements;
- risk assessment of equipment and technology across our production facility to identify opportunities for improvement; and
- drills and other tests of our emergency response provisions and procedures for various hazards (fire, first aid, spills etc.) to improve employee awareness of procedures and provide refresher training.

For key data on our health and safety performance, please refer to the [Data](#) section of this report.

Our offices

Our global portfolio of offices varies from small, leased, serviced offices, to larger self-managed regional and country headquarters. At our smaller offices, health and safety services

are generally provided by the landlord. At larger, self-managed offices, we implement, and directly manage, our health and safety programs to ensure compliance, and to provide a safe, secure, comfortable environment for employees.

Employees in our larger offices globally are actively involved in voluntary health and safety roles, such as health and safety committee members, first aiders, emergency response team members, etc.

Wellbeing Programs

We believe health and wellbeing are critical to our employee’s personal and professional success so employees can create, achieve and enjoy more.

We encourage a healthy lifestyle by providing healthcare benefits, wellness tools, resources and programs to help employees achieve good physical, financial, emotional, intellectual and social wellbeing. With our focus on wellbeing, we help our employees bring their best selves to work and support them and their families through key life experiences. Depending on the location, employees can take advantage of biometric screenings, flu shots, confidential global Employee Assistance Programs (EAP), wellness events and seminars, and our wellness initiatives around the globe continue to grow year-on-year.

Business Continuity

As part of our global business continuity program we have assessed the potential impact of disruptive events (either natural or man-made) to our facilities, and established

Business Resumption Plans that prioritize the health and safety of personnel, emergency communication to affected stakeholders, and the resumption of controlled operations. Refresher training and desktop crisis simulations are conducted on a regular basis.

We continue to manage the impact of Covid-19 under the guidance of our Corporate Crisis Management Team (CMT) and in collaboration with our local site leaders.

With everybody’s health and safety in mind, we implemented work-from-home policies for our employees and responded with compassion to support those employees who have been affected.

With the efforts of our cross-functional CMT, we have not experienced any significant business impacts or interruption to date. We continue to monitor the situation and take measures to mitigate potential disruption and ensure business continuity remains unimpacted during this time.

Our Supply Chain

Our commitment to the safety, health and wellbeing of production line workers also extends beyond our own workforce to fully include factory workers in our supply chain. We work in partnership with our suppliers to drive good practice and continual improvement of health and safety performance. For an overview of our activities within and with supplier organizations, please refer to the [Supplier Development](#) section of this report.

CONFLICT MINERALS

As a committed member of the Responsible Business Alliance (RBA) and the Responsible Minerals Initiative (RMI), we use best practice tools and processes to exert the full influence of the electronics sector on smelters worldwide, and promote responsible sourcing and avoidance of conflict minerals.

Conflict minerals are minerals that are mined in areas of armed conflict and human rights abuse, which finance armed groups. US legislation currently defines Conflict Minerals as cassiterite (tin), coltan (tantalum), wolframite (tungsten) and gold (or derivatives of these minerals), which have been mined in the Democratic Republic of Congo (DRC) or adjoining countries, and which fund conflict. These four minerals are commonly referred to collectively as 3TG.

In 2008, the Responsible Business Alliance (formerly EICC) launched an Extractives Work Group to look at Conflict Mineral risks for the electronics industry. As an active member of the RBA and RMI, Logitech supported the initial assessment work of the RBA's Extractives Working Group. We use the key tools and processes advised by the RBA and RMI to ensure responsible sourcing and avoidance of conflict minerals. As a manufacturer of products that contain 3TG, we understand the importance of avoiding conflict minerals and are committed to sourcing components and materials from companies with

shared values around human rights, ethics and environmental responsibility. We comply with all relevant legal requirements and have implemented a robust due diligence process to help ensure we and our suppliers meet our legal obligations and act in accordance with our values.

In June 2011, RBA launched the world's first conflict-free smelter program. We responded by communicating our first Conflict Minerals Policy Statement to suppliers and launched our Conflict-free Sourcing Program. In 2013, we formalized this position with the publication of our **Conflict Minerals Policy**. This policy is subject to annual review and refresh. It is communicated to all suppliers and embedded into our contractual agreements.

2013 also marked the launch of our Conflict-Free Sourcing Certification Program. Our program aligns with all relevant legal requirements and industry best practice including the OECD Due Diligence Guidance for Responsible Supply Chains of Minerals from Conflict-Affected and High-Risk Areas. It involves us working with

2008

RBA LAUNCHES CONFLICT MINERALS WORK GROUP

2011

RBA LAUNCHES THE WORLD'S FIRST CONFLICT-FREE SMELTER PROGRAM



our Tier 1 suppliers to identify, map and verify our supply chain and ensure Smelters or Refiners (SORs) in our supply chain adequately demonstrate conflict-free status. Mining activity is understood to be crucial to the development of the DRC economy so our program ensures that legal and regulated mining can continue to provide livelihood opportunities to those in need, while eliminating any direct or indirect support of conflict and human rights abuses.

Since 2013 we have worked with our suppliers and other RBA members to exert the full influence of the electronics industry on SORs worldwide, and encourage SOR participation in credible certification programs such as the Responsible Minerals Assurance Process (RMAP, formerly known as Conflict-Free Smelter Program, CFSP). We engage our direct suppliers to raise awareness and understanding of Conflict Minerals risks and our requirements for compliant good practice.

Each year, we review our Tier 1, direct suppliers, identify those that supply materials at risk of containing 3TG. We use the RMI Conflict Minerals Report Template (CMRT) to request information from our direct suppliers and screen 3TG SORs in our supply chain using the RMI's Responsible Minerals Assurance Process (RMAP) and Reasonable Country of

Origin (RCOI) data. Our goal is to only accept 3TG minerals from smelters that are certified as conflict-free, or engaged in the RMAP or an equivalent program¹, and working towards conflict-free status.

Where a supplier is not yet engaged in a program, we work with the supplier to develop Due Diligence Plans showing the actions the supplier will take, within a defined timeframe, to engage, request and encourage smelters to join RMAP or an equivalent certification program, and obtain evidence of conflict-free status. We track and report supplier progress, as part of both internal reporting and reporting to the Securities Exchange Commission (SEC). The results of our combined efforts have reaped tangible outcomes for our own supply chain already, as the number of SORs participating in third-party audit programs and certified as conflict-free has increased year-on-year. A summary of progress to date is shown in the following figures. As shown, for CY19, we again achieved a 100% response rate from our direct suppliers and verified 99% of our active operative smelters are now participating in certification programs and 98% are certified conflict-free.

We are delighted to report that all of our smelters and refiners for tantalum and tungsten are certified conflict-free or participating in a 3rd party audit program. We

100%

CONFLICT-FREE TUNGSTEN

100%

CONFLICT-FREE TANTALUM

98%

CONFLICT-FREE TIN

99%

CONFLICT-FREE GOLD

100%

CONFLICT-FREE TARGET FOR CY20

¹ On a case-by-case basis, we may accept a supplier's use of an "equivalent program", if the program is deemed to be credible and reputable, taking into account the specific materials and suppliers of interest (a number of other schemes are used and advocated by other RBA members e.g. LBMA, RJC).

Conflict minerals

continued

will continue to drive 100% conformance for tin, and gold in CY20. As a responsible and ethical company, we look beyond legal requirements to align with international good practice and grow our program from strength to strength in partnership with our suppliers.

Going beyond regulations: Cobalt Due Diligence

Cobalt is a critical mineral constituent in lithium ion batteries, which are used in many Logitech products. Cobalt is not a “conflict mineral”, as defined by law, but more than 50% of cobalt mining worldwide occurs in the Democratic Republic of Congo (DRC), which is recognized to be a high risk for mining and human rights abuses.

Our first cobalt due diligence surveys started in CY16 and CY17. We started by checking a specific number of SORs, which had been highlighted, via an NGO group, as a potential

concern. For CY18, RBA and RMI extended the RMAP certification program to include cobalt smelters and developed the Cobalt Report Template (CRT). We continued to evolve our due diligence program and leveraged these good practice tools to collect supplier data and identify cobalt smelters.

For CY19, we can report 100% of relevant direct suppliers

responded to our survey effort and 36% our smelters and refiners are participating in the RMAP certification program. Over the forthcoming years, we will build on this baseline and push more cobalt smelters to volunteer and join RMAP or equivalent verified certification schemes by making this a requirement of doing business with Logitech.

Supplier Response Rate

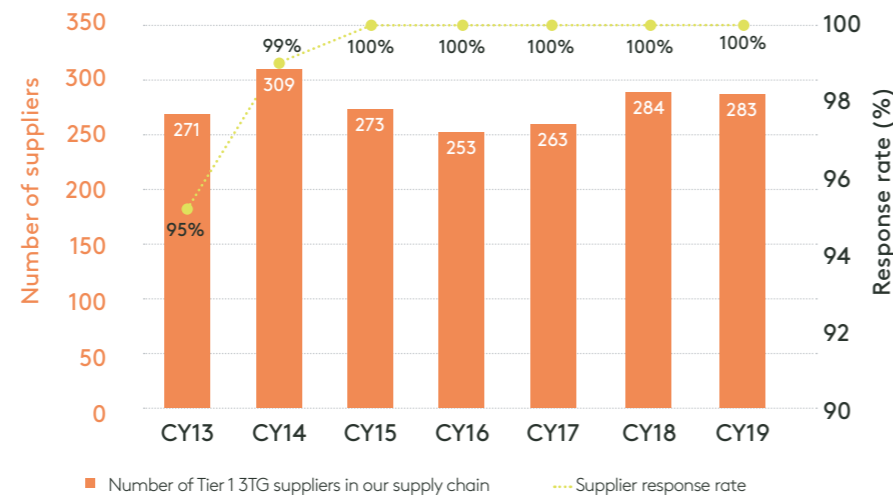

Smelter Progress Towards Conflict-Free Status

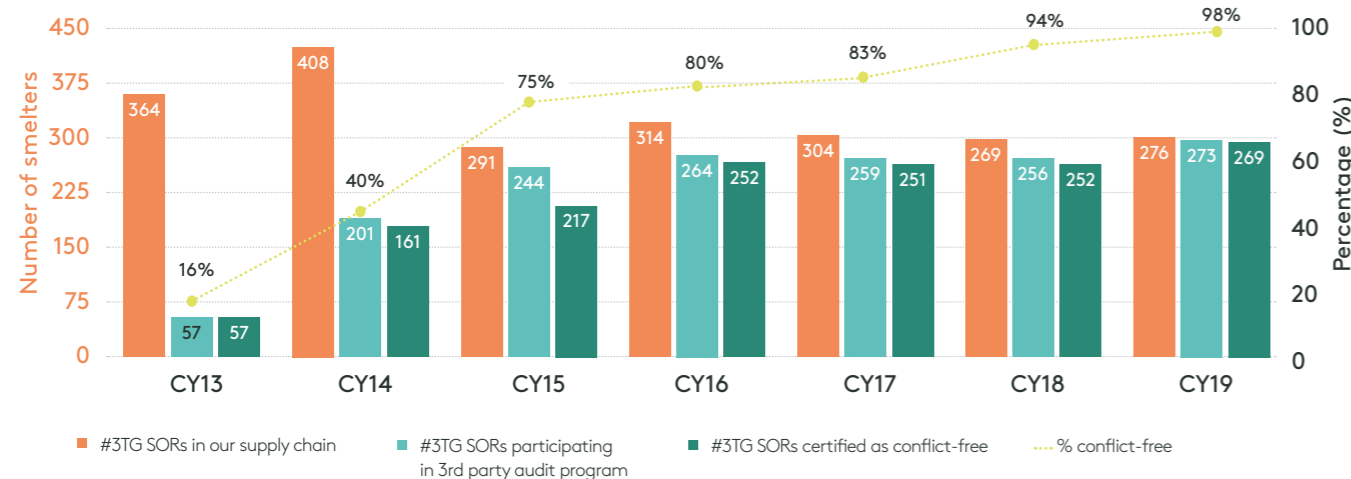

HUMAN RIGHTS AND LABOR

The RBA Code of Conduct is our framework for the management of human rights and labor at our production facility. The RBA Code is aligned with international norms and standards including the Universal Declaration of Human Rights, ILO International Labor Standards, OECD Guidelines for Multinational Enterprises, ISO and SA standards.

Our commitment to human rights and labor management is reflected in the Logitech Code of Conduct, which applies to both our own production facility and our entire supply chain. The scope of our program is summarized in the facing figure.

As set out in our **RBA Commitment Statement**, we have adopted the Code in full and it provides our framework for sustainability, including human rights. Recognizing the importance of human rights, the Logitech Code of Conduct also includes a specific commitment to uphold labor and human rights laws and explicitly communicates our policy to prohibit the use of forced labor, child labor and unsafe working conditions.

As an RBA member, we follow RBA requirements and implement due diligence processes to assess social performance and risks, including human rights compliance and risks. We use the RBA’s Self-Assessment Questionnaire (SAQ)

and Risk Assessment Tool to assess and communicate our performance. Our production facility is subject to periodic third-party audits to verify compliance with the RBA Code, including requirements relevant to human rights and labor management. These audits are carried out by RBA-approved auditors under the RBA validated audit process (VAP) and include site observation, document reviews, interviews with management and employees. Audit findings are rated as “minor,” “major” or “priority” and are reviewed and validated by a second, independent consulting firm, to ensure accuracy and objectivity. For all three categories of finding, the auditee has a defined period of time to prepare and implement Corrective Action Plans (CAPs), remedy the identified issues, and implement systems to prevent a recurrence. Any potential, perceived or actual violation of human rights and related RBA Code aspects are taken very seriously.

During FY20, our production facility underwent an independent VAP audit in April 2019 and again in November 2019. The most recent audit resulted in a VAP audit ‘Silver’ rating (see certificate [here](#)). The remainder of this section provides an overview of the key risks and management processes we have in place, to manage relevant issues.

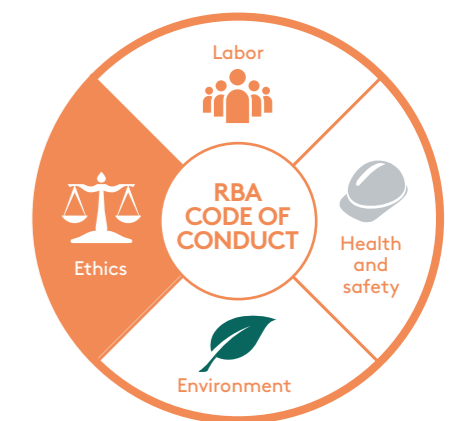

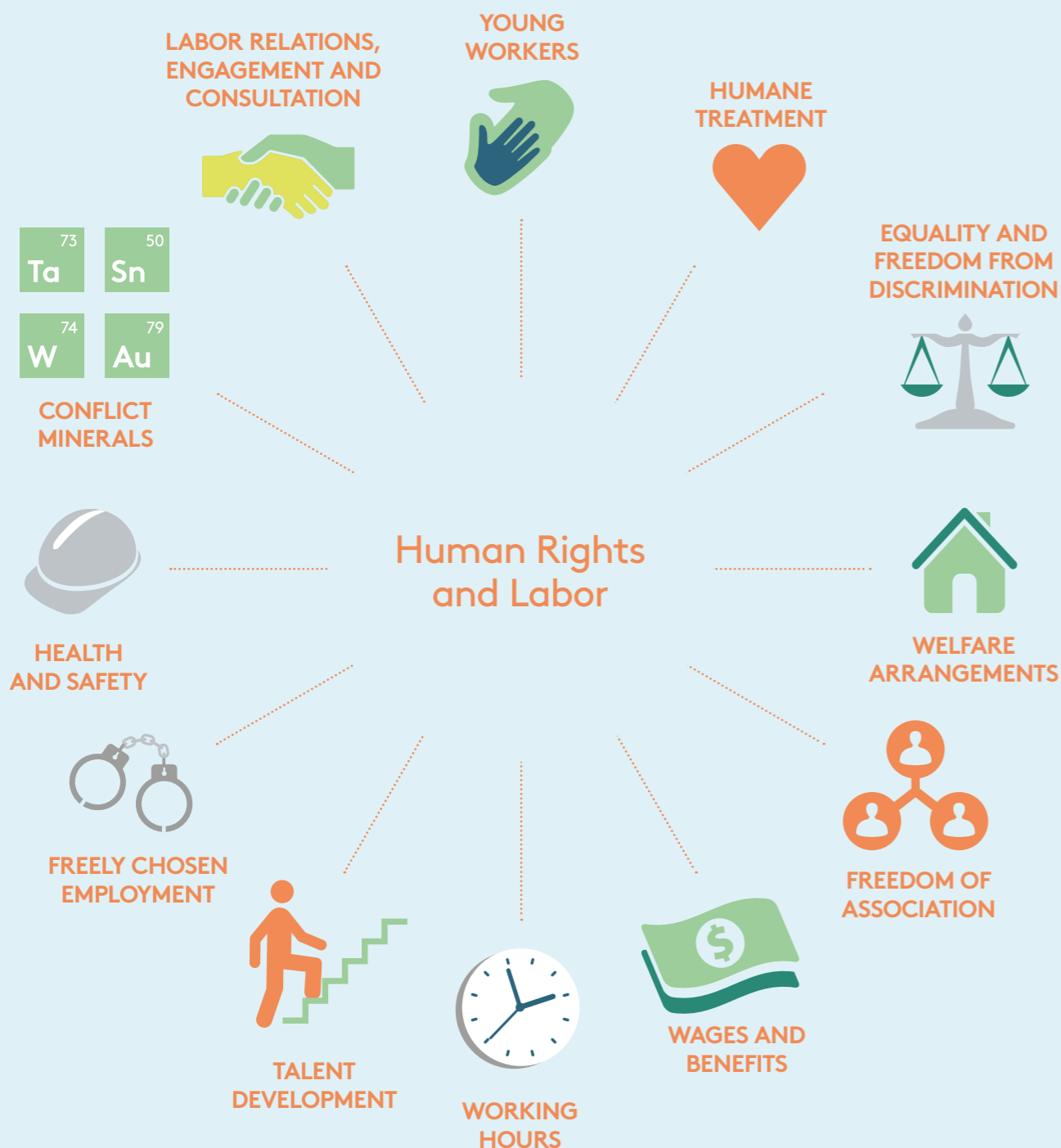

Freely Chosen Employment

Our requirements in relation to Freely Chosen Employment include Zero Tolerance for any type of forced, involuntary or exploitative prison, indentured, bonded (including debt bondage), trafficked or slave labor.

As part of the hiring process, workers are provided with a written employment agreement in their native language. This agreement describes the terms and conditions of employment. Workers are free to terminate their employment at any time. Holding employee documents (IDs, passports, work permits, etc.) is strictly forbidden and workers are not required to pay recruitment fees or other related fees. We have long-term, established relationships with a limited number of trusted recruitment agencies and our requirements for due diligence checks are built into our contractual agreements with these agencies. We audit the recruitment activities of these agencies and we also carry out worker interviews as part of new-hire orientation and check to ensure workers have not paid any recruitment fees, as part of this process.

To demonstrate our commitment to Freely Chosen Employment, and in alignment with the legal requirements of the California Transparency

in Supply Chains Act, we introduced a **Statement on Slavery and Human Trafficking** in 2012. This statement also incorporates the requirements of the UK Modern Slavery Act and the Australian Modern Slavery Act of 2018. The statement is subject to review and update by our Board of Directors on an annual basis. The latest version of the statement is available on our website and communicates the key mechanisms we have established to eradicate the risk of slavery and human trafficking.



Young Workers

Our requirements in relation to Young Workers reflect RBA requirements and include Zero Tolerance for child labor. Child Labor is defined as work by any person under the age of 15, under the age for completing compulsory education in the country of origin, or under the minimum age for employment in the country of origin (whichever is greatest). Workers under the age of 18 are protected from work that could potentially impact their health or safety (e.g. night shifts and excessive overtime). Apprentices, Interns and Student Workers can only be employed when adequate policies and procedures are in place. We check identification documents and interview a sample of workers on a periodic

basis to verify employee age, as part of our internal and supplier audit programs.

In April 2019, VAP Auditors identified one priority finding, in relation to Young Workers - student workers were found to be working overtime and night shift. This is not in line with our company policy or RBA requirements. It is an unacceptable situation that we work hard to avoid. We outlined a corrective action plan to fully address the issue and we have put measures in place to ensure this type of issue is avoided in the future. This issue has been fully resolved and verified as such via an independent VAP follow-up assessment.



Working Hours

Eliminating excessive overtime is a key commitment of ours and a key requirement of the RBA Code of Conduct. It remains a significant challenge for our sector as a whole. While all overtime hours are done so on a voluntary basis and requested or agreed by workers directly, excessive overtime can have adverse effects on the safety and wellbeing of workers and over long periods can have impacts on health, and quality of life. The root causes of excessive overtime are usually forecasting, capacity planning issues, shortened production

Human Rights and Labor

continued

timelines and seasonal spikes in production demand. Traditional compensation models also often reward overtime with additional pay, which can sometimes encourage workers to request working hours in excess of that permitted by local law or endorsed by RBA.

In April 2019, VAP Auditors identified one major and one minor finding, in relation to working hours at our production facility. For a sample of employees hours worked during a workweek exceeded 60, which exceeds RBA requirements. We continue our efforts to train, educate and communicate good practices and approaches to enable better management of the working hours at our production facility and perform regular management reviews of performance versus findings. VAP Auditors also identified a major finding, in relation to management of working hours of contractors. We put measures in place to address this issue and closure of this finding was verified by third-party VAP Auditors during a follow-up audit in November.



Wages and Benefits

Our approach and compensation structures are fully aligned with the RBA Code of Conduct requirements. Worker compensation complies with all applicable wage laws, including those relating to minimum wages, overtime hours

and legally mandated benefits. Workers are compensated for overtime, at pay rates greater than the regular hourly rate. Deduction of wages as a disciplinary measure is not permitted. Workers are provided with wage statements and we carry out worker interviews to ensure workers know how to check and verify that they have received accurate compensation for work performed.



Humane Treatment

The RBA Code of Conduct includes requirements to ensure humane treatment of workers and safeguard workers from actual or threatened sexual harassment, sexual abuse, corporal punishment, mental or physical coercion or verbal abuse.

We have clearly defined policies and disciplinary procedures addressing these risks and those policies and procedures are communicated to workers. In reality, we look to significantly surpass RBA requirements for humane treatment, and instead be known as an employer of choice, and a place where workers feel respected and fully engaged, as members of the global Logitech team.



Equality and Freedom from Discrimination

We are committed to providing a workplace free from harassment and

unlawful discrimination. We have established recruitment and employment practices to safeguard against discrimination based on race, color, age, gender, sexual orientation, gender identity and expression, ethnicity or national origin, disability, pregnancy, religion, political affiliation, union membership, covered veteran status, protected genetic information or marital status.

Workers or potential workers are not subjected to physical exams that could be used in a discriminatory way. Our policies and practices reflect RBA requirements, and compliance with the RBA Code is stipulated as a requirement in our contracts with suppliers and recruitment agencies. We check and compare the wages, rewards and training records for various individuals at our production facility to ensure discriminatory practices are not implemented in any area.



Freedom of Association

We respect the right of all workers to form and join trade unions of their own choosing, to bargain collectively and to engage in peaceful assembly, as well as the right of workers to refrain from such activities.

We maintain an open-door policy and provide workers the opportunity to openly communicate and share their ideas and concerns with management regarding

working conditions and management practices without fear of discrimination, reprisal, intimidation or harassment. Key mechanisms of employee engagement are described further in the **Stakeholder Engagement** section of this report.



Conflict Minerals

Management of risks relating to Conflict Minerals is a key part of our human rights program. For further information on this aspect of our sustainability performance, please refer to our **Conflict Minerals Policy** and the **Conflict Minerals** section of this report.



Health & Safety

We have an established H&S management system, which is certified to international health and safety standard ISO 45001 and compliant with the RBA Code of Conduct, which reflects ILO Guidelines on Occupational Safety and Health.

We work in accordance with RBA requirements including specific provisions relating to the Hierarchy of Controls and addressing key risks associated with our sector e.g. emergency preparedness, management of occupational injuries and illnesses, industrial hygiene, physically demanding work and machine guarding.

We aim to establish and maintain a safe and healthy work environment, which enhances worker retention and morale and recognize the essential need for ongoing consultation, communication, training and education to identify, manage and solve health and safety issues in the workplace.

In April 2019, VAP Auditors reviewed our Industrial Hygiene Management Plans and identified one major finding, relating to the use of qualified agents for evaluations. We outlined a corrective action plan to fully address the issue and we have put measures in place to ensure this type of issue is avoided in the future. This issue has been fully resolved and verified as such via an independent VAP follow up assessment.



Welfare Arrangements

Welfare facilities are provided in accordance with RBA Code requirements and include toilet and sanitary facilities, potable water, food preparation, storage, and eating facilities. Worker accommodation is maintained clean and safe, and provided with appropriate emergency access and egress, hot water for bathing and showering, adequate heat and ventilation, and reasonable personal space. Our overall objective is to significantly exceed RBA

2009

RBA VALIDATED
AUDIT PROCESS (VAP)
ESTABLISHED

Human Rights and Labor

continued

requirements and provide facilities that enhance the daily working life of employees and ensure our production facility is a great place to work.



Talent Development

Our employee development programs offer workers the opportunity to grow, learn new skills and develop.

Our dedicated training center at our production facility includes workshop facilities, presentation areas and simulated production lines for workers to try out and learn new skills. New employees are provided with robust induction training and put forward for additional training following defined periods of on-the-job



experience.

Labor Relations, Engagement and Consultation

Ensuring open, two-way dialogue between managers and employees helps us build and maintain trusting, loyal and long-lasting relationships. We look to foster an open collaborative environment where people feel empowered to give and solicit candid feedback. This philosophy and approach is communicated as part of employee induction and orientation.

At our production facility, we conduct regular team meetings and utilize mobile chat to share company news and leadership updates in local language. More formally, we conduct periodic worker interviews to collate and understand employee views, provide suggestion boxes

and an anonymous whistle-blowing mechanism, which employees can use to submit comments, confidentially.

Supply Chain Standards

Further information on our approach to the management of human rights and labor performance at supplier facilities and across our supply chain is provided in the [Supplier Development](#) section of this report.

SUPPLIER DEVELOPMENT

Our continued success is coupled to the continued success of our suppliers. We look to establish long-term relationships with our suppliers, based on shared values of ethics, good practice and RBA Code compliance.

As a small company, playing in a global market, we recognize the value of collaboration. We joined the Responsible Business Alliance (RBA) in 2007, to collaborate with industry peers and competitors alike and develop tools and programs addressing the sustainability challenges facing our sector today. The RBA has an established Code of Conduct ("the RBA Code"), which is reflective of international norms and good practice, including the Universal Declaration of Human Rights, ILO International Labour Standards, OECD Guidelines for Multinational Enterprises, ISO 45001, ISO 14001 and SA8000. We have adopted the RBA Code in full, as indicated in our [RBA Code Commitment Statement](#). It is fully reflected in our internal policy framework and is our framework for supplier management.

Approximately 50% of our annual revenue is generated from the products we manufacture at our own production facility, where we are primarily engaged in final assembly and testing activities for components supplied by a network of Component Manufacturers. The other 50%

of our revenue (approx.) is generated from products that are manufactured by Joint Design Manufacturers (JDMs) and Contract Manufacturers, working to our specifications and with our oversight. We work in partnership with our suppliers to ensure Logitech products are produced in accordance with international good practice sustainability and quality. RBA Code compliance is a requirement in supplier contracts, provides the framework for our audit program, and is embedded in our due diligence process for mergers and acquisitions as well as new company or new supplier qualification and integration. We also require suppliers to apply the RBA Code to their own suppliers, thus driving RBA Code adoption across our full value chain, as a condition of doing business with Logitech.

Supplier Performance and Auditing Activities

The RBA Code defines Major Suppliers as the suppliers who account for 80% of direct spend. We audit all our Major Suppliers each year and also any other suppliers, who are

deemed to be "high-risk", as per our risk assessment criteria.

Our Major Suppliers do not significantly change year-on-year. High-risk suppliers must be identified by risk assessment and the RBA provide guidance and tools for that process (e.g. RBA's Self-Assessment Questionnaire (SAQ) and Risk Assessment Tool). At our request, suppliers use these tools to carry out a self-evaluation of their performance and to disclose pertinent information regarding their business activities and organization. We carry out a desk-based review of that information to verify accuracy and completeness, and determine the level of risk and the need for on-site audit. We consider a number of factors including the type of supplier (e.g. 100% of JDM's are considered high-risk, because of their critical role in product manufacturing, 100% of new suppliers are considered to be high-risk during the early stage of our relationship, while we work to verify alignment with good practice expectations).

We also take into account the supplier's manufacturing processes (e.g. spray-painting

Supplier Development

continued

suppliers can be high-risk because of potential impacts on the environment and product experience), and risks associated with the supplier's country location. Any supplier who scores less than 65% on the RBA's Self-Assessment Questionnaire is also considered to be high-risk. Major and High-risk suppliers are included in our audit plan for the year and both Tier 1 and Tier 2 suppliers are considered, as part of this risk-based assessment. We call the resulting pool of suppliers our In-Scope Suppliers.

Compliance with the RBA Code of Conduct (including all provisions relating to human rights and labor) is a contractual requirement of all Significant Investment Agreements.¹ To this end we:

- screen 100% of new suppliers as part of our established prequalification process to

check and verify supplier compliance with Priority Aspects² of the RBA Code and legal requirements; and

- audit 100% of other In-Scope Suppliers, at least annually, to check and verify continued compliance with all aspects of the RBA Code.

With our Customer Managed Audit (CMA) process, we replicate the Validated Audit Process (VAP) approach that is implemented and advocated by RBA and use RBA-endorsed VAP protocol and tools. In CY19, we completed 80 supplier audits covering 100% of our In-Scope Suppliers and 100% of new suppliers. Our audit process includes a full process for corrective action planning, tracking and reporting. A sample of the types of findings we are identifying is provided below (organized by RBA Category).

Supplier Strategy

Our Quarterly Business Review (QBR) process is where we consider sustainability performance as an integral part of supplier performance, to inform our supplier strategy and business decisions. The QBR process involves an assessment of six main categories of supplier performance: Engineering, Sustainability, Quality, Demand/Supply capability

100%

NEW SUPPLIERS AUDITED

100%

IN-SCOPE SUPPLIERS AUDITED

	CY19
Number of In-Scope Factories	44
% of In-Scope Factories audited for RBA Code Compliance	100%
Number of audits completed	80
Number of New Factories	24
% of New Suppliers audited	100%

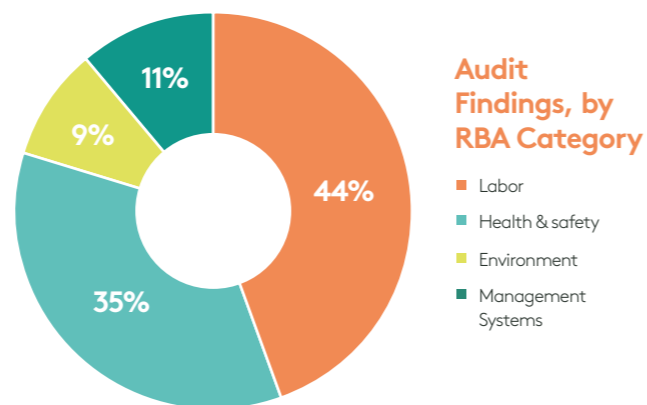

¹ This term "Significant Investment Agreement" is aligned with the definition used by the Global Reporting Initiative (GRI) and used to describe contractually-binding Supplier Agreements established between Logitech and our direct suppliers.

² The RBA term "Priority Finding" is a nonconformance which has significant and immediate impact. RBA quotes the following examples: Health and safety issues that can cause immediate danger to life or serious injury; environmental issues that can result in serious and immediate harm to the local environment or community.

and Commercial aspects. For quantitative elements of the assessment process, engineering performance carries a 25% weighting and other categories of performance (including sustainability performance) each carry a 15% weighting. However, the scoring process is only one part of the QBR process and we adjust the focus of the review, where necessary to also consider alignment with company sustainability policies, objectives and key risks, which cannot be easily quantified. Suppliers who receive high QBR scores are identified in our approved supplier list with a "preferred" status. They benefit from additional development opportunities, including a greater opportunity to expand their business and relationship with us. Suppliers with low QBR scores are subject to additional auditing and commercial restrictions (e.g. no new contracts) and ultimately termination if performance does not improve.

Supplier Capability-Building

We understand auditing alone is not enough to develop a supplier. We host and facilitate supplier capability-building events, where we facilitate discussions of Logitech standards and international good practice, while helping suppliers to share best practices and lessons learned, with each other. We also connect our suppliers with RBA capability-building sessions and development resources and encourage their participation

in such sessions, to achieve independent certifications.

In the last year, we provided supplier training on a number of topics, including occupational health and safety, and labor management expectations relevant to dispatch (contract/ agency) workers. Our on-site engagement program of capability building and audits continued in FY20 to help suppliers understand our good practice requirements, identify where improvements could be made, and develop real and measurable improvement plans to enhance the lives of real people, their communities and the environment.

For our annual Supplier Conference, exceptional circumstances (travel restrictions due to Covid-19 outbreak) lead us to transition the usual live event, to a Zoom Webinar forum. The Zoom webinar format allowed us to more than double supplier attendance, with almost 40% of participants confirming they were attending from home. Our goal was to provide our key suppliers an update on our business, trends and expectations for the coming fiscal years and this year, we placed particular emphasis on sustainability, with sessions on climate action, renewable electricity and design for sustainability. We invited suppliers to partner with us for change. We also continued our supplier incentivization

program, with the award of a Logitech Torch Award for most improved sustainability performance. We introduced the Sustainability Torch in 2016, to acknowledge our commitment to leading the way to a more sustainable future, and "passing the torch" to our suppliers.

We want to make sustainability a pervasive part of supply chain sourcing and manufacturing. We're targeting areas where we have the greatest potential to create value and lead the way.

“

In the past year, Logitech has put an invigorated focus on both people and communities because we have an ambition that 'together we can drive big change.' There's no question that now, more than ever in our recent history, it is our responsibility to not only do what's right for, and brings out the best in, our people; it's our responsibility to help level the playing field for all people to create more fulfilling lives.

Kirsty Russell
Head of People & Culture

”



In the past year, Logitech has put an invigorated focus on both people and communities because we have an ambition that 'together we can drive big change.' There's no question that now, more than ever in our recent history, it is our responsibility to not only do what's right for, and brings out the best in, our people; it's our responsibility to help level the playing field for all people to create more fulfilling lives. And by dedicating ourselves to the communities in which we live and work, either as Logitech or by joining forces with others, we're doing our part to create more inclusive communities and a more just society. The following areas of this report will provide an overview and highlights of Logitech's social handprint - our framework for making a positive impact on people - and the various ways we take this from theory to practice.

While this report is focused on the past year's events, I'm compelled to fast-forward to today because it's difficult not to address the unprecedented times we've all been navigating. And even through the challenges of today, I continue to be impressed by how every individual, team, and Logitech site continues to do

whatever they can to give back to their local and professional communities. In fact, our people's dedication to bettering people and communities is such a common thread that we've expanded our cultural values to celebrate this, and to continue to demand it. For quite some time, we've taken pride in being **Open & Ourselves**, and **Humble but Hungry**, that we **Decide & Do**, and **Collaborate but Challenge**. We've now added **Equality & Environment** as a new cultural value. The sentiment of the new value has always been in the company, but we are working harder than ever to offer equitable opportunity and equal access to resources no matter your gender identity, race/ethnicity, sexual orientation or other diversity dimension. There is so much we need to do, and so much that we're ambitious to do; I am proud to be with a company and people that are up for the challenge.

Kirsty Russell
Head of People & Culture

DIVERSITY AND INCLUSION

At Logitech, we are beautifully diverse. This gives us the unique perspectives and experiences needed to innovate, understand different markets and pull together across the globe to make things happen locally and build a competitive advantage.

We foster an inclusive culture where employees can bring their whole selves to work and fully contribute their skills and talents. We want our employees to be valued and supported both at work and in their communities.

In FY20, we continued our diversity and inclusion journey with a closer examination of how we could drive inclusive business practices from ideation, product development and marketing to collaboration with partners. We are particularly proud of the Logitech G Adaptive Gaming Kit for gamers with limited mobility. We believe that “Life is More Fun when you Play.” Logitech G launched Creator Spotlight to raise the visibility of the creators that we work with. Logitech works to highlight underrepresented streamers and creators because we believe “you can’t be what you can’t see.”

To foster a more inclusive environment, we continued regular training sessions to emphasize awareness of self, bias and privilege as well as what everyday inclusive action looks like.

We frequently update our people processes as systematic

infrastructure changes alongside behavior changes are key to addressing bias. We embed diversity metrics in our Organization and Talent Reviews so that leaders review progress and take actions in support of our Diversity and Inclusion Strategy. Our hiring, salary, bonus and promotion processes are refreshed regularly with an eye to evenly applied criteria and fair decision making. In FY20, we implemented an employee engagement platform with behavior change nudges to provide regular prompts for a happier and more inclusive culture.

We sponsored conferences and events globally such as Women in Data Science Zürich, Silicon Valley Pride, Breaking Glass’ Womxn of Color Forum and TechGig Geek Goddess in India. Our growing employee affinity groups help employees create community, develop as leaders, share opportunities and organize participation in local or regional events.

We encourage all of our employees to positively impact diversity and create inclusive environments, both internally

and externally. At our Swiss headquarters, we continued our ongoing partnership with Ecole Polytechnique Fédérale de Lausanne (EPFL) to encourage and support girls in STEM by hosting students for coding camps and workshops.

At our production facility, we ensure equal pay for equal work and periodically benchmark our benefits packages with relevant peer companies and good practice. We work with our suppliers to maintain the same standards at our supplier facilities, with periodic audits to check working hours and any gender bias in relation to remuneration, benefits or development opportunities.

In June of this year, our CEO made a **Diversity Pledge**, setting out seven key commitments to diversity action, from our products, to our employees, to our procurement practices, to our suppliers. We believe our supply base should be reflective of the diversity of the communities and markets that we serve. As a global company operating across a diverse range of markets, we believe our customers are best served

by a team of equally diverse internal and external partners. A diverse and inclusive supply base creates invaluable opportunities to hear different perspectives, generate new ideas, understand different markets and build a competitive advantage.

Our Diversity Pledge is shown overleaf. As shown, we have pledged to support suppliers

and partners that are Black-owned, women-owned and owned by other underrepresented groups and we have committed to reporting our own performance in this area, as a corporate metric, with an associated improvement goal. We have also pledged to increase our investment in recruiting, developing, and

promoting underrepresented suppliers and support education and awareness at every level.

We are becoming an outspoken champion for inclusion outside our own walls and we expect to be held accountable for significant improvement in the years ahead as we work to create and advocate for an equal playing field for all.





"WE PLEDGE TO MAKE DIVERSITY A PRIORITY"

BRACKEN DARRELL, CEO

1 We Will Speak Up, Speak Out: Be A Voice For Change, Even As We Change Ourselves.

We will become an honest and authentic advocate for stopping racism. As a company, we have often been too quiet on social and political matters but will become a more consistently vocal advocate. By sharing that we are acting but not there yet, we hope we can play a small role in encouraging others to do the same and to be transparent and accountable.

2 We Will Support Other Activists For This Change.

We offer a global Volunteer Time Off and employee donation matching program, but these are just a start, we will now do more. We will make multi-year commitments to organizations that explicitly work to improve fairness and eradicate racism. We will expand our support of schools and nonprofits in under-supported communities with financial contributions, volunteering, and product donations

3 We Will Support Our Communities.

We have a history of investing and mentoring entrepreneurs and will look at the makeup of our investment to ensure innovation and ideas are coming from a diverse set of voices. Specifically, supporting Black and minority founders as they create new businesses (Incubators, VC funds, Joint ventures, etc). We have partnered with Best Buy to fund and support a teen tech center for the Boys and Girls Club in California and will target opportunities to support other STEAM centers in underserved communities

4 We Will Support Suppliers And Partners That Are Black, Women And Minority Owned.

We are committed to growing the number of suppliers owned by underrepresented groups across the globe and pledge to **five key actions**. We will concentrate on these five key actions in the US initially where advocacy groups are most well established, we can most easily track our impact and we will be able to make a positive impact fastest. We will continue to learn whilst doing this and once our model is working we will take it worldwide.

5 We Will Transparently Measure And Report Our Improvement.

We will evolve from the inside out. We actively review and invest in diverse representation and pay equity at Logitech and will accelerate our plans for sharing our numbers publicly. We will increase our investment in recruiting, developing, and promoting Black and other underrepresented people.

6 We Will Support Education at Every Level.

Starting with our own company, we will educate our leaders and all employees on anti-racism, continually. We will also support education in schools to free the next generations from this injustice.

7 We Will Never Stop. We Will Make Mistakes, And We Will Learn.

This job isn't done until the playing field is level for all, including black people, other people of color, LGBTQ+, women, and all other underrepresented groups.



TALENT DEVELOPMENT

We prosper when we develop our people. We look to embed a learning culture, where employees feel empowered to nurture their own minds, challenge ideas, and make things better.

Many companies aim to get the most out of their employees. Not us. We want to bring out the best in our employees. We believe there is no real value in separating an individual's work skills, from their character, and their life experience.

We cannot expect to meet ever-increasing business aspirations, unless our people also see opportunities to meet their personal aspirations.

Our employee development programs offer individuals the opportunity to build skills and gain insights relevant to their lives as a whole, including their lifestyle. LogiLearner provides a wealth of curated learning opportunities, so employees can learn in a way that fits with their schedule. From short videos to extended programs, there is something for everyone's preferred learning style.

GLOBAL LEARNING

Dedicated Training Center

At our production facility, we have a dedicated training facility, which includes workshop facilities, presentation areas and simulated production lines for workers to try out new skills. New employees receive

a comprehensive orientation and focused skills training to build specific competencies e.g. hand welding, assembly, testing, packaging, quality checks etc. This is followed by on-the-job training and on-line practice, with periodic refresher training and testing. Our supervisors look for opportunities to encourage, train and develop employees, where possible to grow and retain talent.

Flagship Program for Leadership Development

Our flagship program provides a workshop-based, leadership development program for employees at all levels across the company. With Logitech's culture as our foundation, the program provides a tool-kit to amplify the talent, creativity, capability and enjoyment of individuals and teams. Since 2015, the program has been delivered in more than 20 locations worldwide and more than 2,000+ employees have participated.

PEOPLE LEADERSHIP

Mentorship and Coaching Program for Emerging Leaders

We believe all employees are leaders, regardless of formal management roles, and we

have designed a program for individual contributors to develop their professional competencies and interpersonal skills, to further contribute to a culture of leadership. This program includes 360° feedback, leadership coaching and a structured mentorship with a Logitech leader. In FY20, 122 employees participated. To date, more than 550 employees have completed the program.

New Manager Fundamentals and Growth

We offer a six-month program for new managers that includes building a management fundamentals skillset and mindset, whilst receiving 1:1 coaching and a 360° assessment via a cohort-based model. Sixty-five (65) managers completed the program in FY20 and 85% of the target manager population has received the training over the last number of years.

Experienced Manager Development

This two-day program is for seasoned managers and accelerates leadership impact. The session includes a comprehensive 360° assessment, 1:1 coaching, and innovative tools to create deep, personal change. Since 2017, more



than 250 managers have participated in the program, which is more than 50% of the target manager population.

TEAMS AND TRANSITION

New Leader Assimilation Process

When new managers come into Logitech or existing managers transition to lead a new team, we provide support to get them up to speed with their team. New teams participate in a facilitated session designed to accelerate communication, relationship and common purpose between the new leader and his or her direct reports. The session is followed with additional resources, a review with the leader, defined next steps, feedback and coaching, where needed. The new leader assimilation helps new managers to quickly develop relationships with their direct reports during their transition period.

Career Development

After delivering employee-centric and leader-led roadshows at more than 15 locations in FY17, we recognized the need for a greater focus on helping people map how they contribute to the organization whilst furthering their professional development. To address this need, we rolled out Career Development workshops to more than 2,000 employees worldwide in the last three fiscal years. Managers were equipped with tools to support meaningful career development conversations and coaching skills, while employees were given structured tools to identify focused development goals and activities to progress their goals.

Targeted Team Development

To help teams improve the climate, morale, and performance of their teams, tailored learning opportunities are provided to support team performance. Topics

12,000+

TOTAL TRAINING HOURS

Talent Development continued

included, but were not limited to, the following:

- Strategic priorities, goals and benchmark
- Team operating rhythms
- Followership models
- Trust and psychological safety
- Team norms
- Meeting protocols and communication mechanisms

After each session, the facilitator sends follow-up resources for the leaders and provides any additional feedback and coaching, to help define next steps for the teams and/or leader's development.

Our efforts in this area are already delivering great outcomes. Feedback from employees indicates the learning opportunities are well received and have a meaningful impact.

We believe this work helps create a shared identity through meaningful and memorable experiences that have opened our employees' minds and hearts to new ways of leading and living. We continue to be ranked as an Attractive Employer by Universum Global Switzerland and we look to continue that trend and position ourselves as an Employer of Choice.



GIVING BACK

Together we can drive big change. Through our give back program, we enable people to design more fulfilling lives and a better planet. We believe giving back and driving change are not only our social responsibility, but a key aspect of our culture.

At Logitech, we are advocates for people. We want to have a positive impact on society and we want this impact to be felt over time. In pursuit of this goal, we empower our people to give back to communities meaningful to them and their work, and we look to maximize our impact by leveraging our people's skills and our products.

- Empowering our people: Our employees contribute to the causes they have a personal passion for, and we maximize their contributions.
- Our local communities: We create opportunities for employees to work together to give back to the communities in which we live and work.
- Leveraging skills and products: We leverage the skills and products that our people and company have to offer, to better the lives and futures of others.

The purpose and values underpinning our give back program reflect our passion and belief that Logitech should be more than just a great place to work; it should help connect our personal values and organizational values by building a community of people who care. The philanthropic spirit of our give back program is deeply rooted in our values, from our early focus on people, as the cornerstone of our culture, to our focus on doing the right thing, across all areas of the business.

During FY20, employees across the company organized and delivered approximately 23 give back events across 13 cities in 9 countries, including Taiwan, India, USA, Mexico, Singapore, China, Ireland, United Arab Emirates and Switzerland. The remainder of this section provides examples of give back initiatives that employees organized around the world in the last year.

400+

VOLUNTEERS
AND ORGANIZERS

23

GIVING BACK EVENTS

2,200+

VOLUNTEER HOURS



BOYS' & GIRLS CLUBS
ASSOCIATION



RAMADAN BREAKFAST DONATION



CASA DE LA AMISTAD

Boys' & Girls' Clubs Association (BGCA), Hong Kong

Founded in 1936, the Boys' & Girls' Clubs Association of Hong Kong (BGCA) is one of the longest-serving, local, charitable organizations in Hong Kong. BGCA works to raise awareness and support the welfare of children and young people, particularly from disadvantaged groups.

A team of 11 employees accompanied children and their parents and BGCA social workers on a visit to the Hong Kong Science Park. This visit

helped children from low income families learn more about how technology can change lives and introduced them to STEM concepts.

Casa De La Amistad, Mexico City

Casa de la Amistad's (CDLA) mission is to help increase the survival rates of Mexican children and young people with cancer, from low income backgrounds. CDLA provides no-cost cancer treatment and accommodation for children and their families, as well as food, educational and emotional

support. During a Logitech visit, our employees donated items and entertained the children, with artistic activities.

Ramadan Breakfast Donation, Dubai

Ramadan is about caring, giving and a time of sacrifice for the Muslim community. When authorities in Dubai decided to provide refrigerators across Dubai city to serve the less fortunate, our team helped stock by contributing food and beverages.

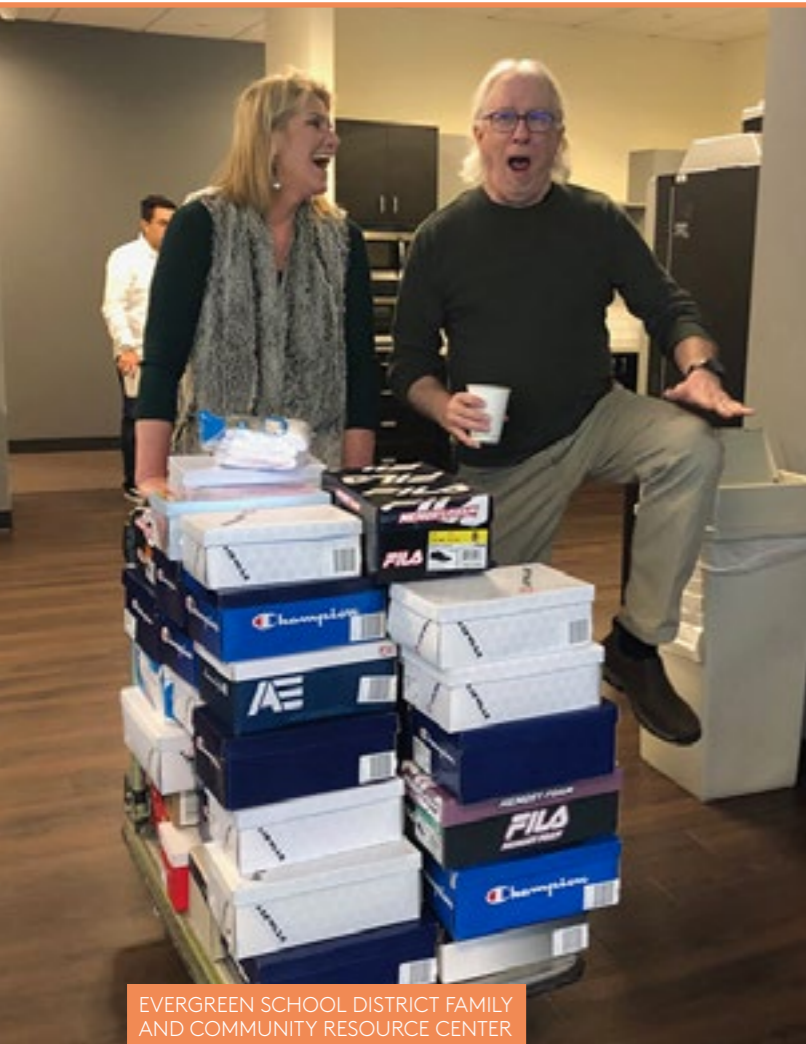
EVERGREEN SCHOOL DISTRICT FAMILY
AND COMMUNITY RESOURCE CENTER

CHUNG YI SOCIAL WELFARE FOUNDATION



BEACH CLEAN-UP AT LEO CARRILLO STATE PARK



HABITAT FOR HUMANITY-HOME AND PLAYHOUSE BUILD

Adopt an Angel, San Francisco

The Adopt an Angel program supports Alameda County Child Protective Services in the San Francisco Bay Area. During the holiday season, program coordinators from the Adopt and Angel program help children in care compile a "wish list" of items they would appreciate. Our Silicon Valley office has contributed to the program for almost 20 years and in 2019, employees prepared more than 2,400 gifts, which were distributed to more than 800 children, living in group homes, shelters, foster care or low-income homes.

Evergreen School District Family and Community Resource Center, Camas

The Evergreen School Family and Community Resource Center gives students and families the tools they need to learn and grow. The center helps families with basic items, including school supplies, food, clothing, shoes and toiletries. They also help individuals access community resources, while offering parenting resources, employment connections, continuing education, housing and utilities resources and early childhood education.

A number of children in the Evergreen School District have experienced homelessness and

receive free or reduced-price lunches from the state, each year. Our team in Camas hosted a shoe drive, to raise funds for the Center and donated 'snacks' for the state-funded lunches that are provided at schools.

Anaikkum Karangal Children's Shelter, Chennai

Anaikkum Karangal is a children's shelter run by Bhumi NGO. Employees from our Chennai office visited the shelter and made and donated notebooks and flashcards, which the children could use in school. Employees also set up fundraising events, gathered donations, prepared refreshments and hosted

games, to raise funds and help six students through higher education, and support broader child welfare and women's empowerment programs.

Chung Yi Social Welfare Foundation, Taiwan

The Chung Yi Social Welfare Foundation was established in 1951 and set up several homes in Taipei to provide housing and supportive services for disadvantaged children and young adults. Volunteers from our Taiwan Welfare Committee and Taiwan office set up a booth to wash, pack and sell fruit, coffee cupcakes and children's books, to raise funds and support Chung Yi's Children's Home.

Beach Clean-Up at Leo Carrillo State Park, California

The Leo Carrillo State Park was burned in the Woolsey Fire of November 2018, destroying the campground and park structures. A team of 27 employees held a beach clean-up initiative to support the restoration efforts.

Habitat for Humanity-Home and Playhouse Build, California

Habitat for Humanity builds homes and creates affordable home-ownership opportunities for low-income families in Marin, San Francisco, and San Mateo counties. Habitat East Bay/Silicon Valley has partnered with

the City of Fremont to build a 30 home development featuring a large community area for family and children to play as well as private decks and balconies. A team of volunteers from our SVC office helped to frame walls, build door and window packages and cut and sort lumbar during the construction of the second phase of the development.

Habitat for Humanity's Playhouse Program facilitates Habitat volunteers coming together to work as a team and build playhouses for local families and community partners. A team of employees from our SVC office participated in the program and built three playhouses.

CORK SIMON COMMUNITY AND
COBH COMMUNITY HOSPITAL

Cork Simon Community and Cobh Community Hospital, Ireland

Cork Simon Community works in solidarity with men and women who are homeless in Cork, offering housing and support to help them on their journey back to independent living. The community provides round-the-clock care for men and women whose health and other needs are such that they are not able to live independently. Cobh Community Hospital provides a residential home for the elderly. Residents are cared for, supported and valued in a person-centered environment that promotes

the individual health and well-being of residents.

Our team in Cork organized a number of activities to raise funds for both organizations and more than 60 employees participated in volunteering days to give both organizations a refreshing face-lift with lots of new plants, painting, cleaning and energy. We are incredibly proud of the work that both organizations undertake and were humbled to work with their teams to live our company values and make a positive impact on local communities, while also making a real difference to people at these charities.

Téléthon, Switzerland

Téléthon is a Swiss association that helps orphans and children with Myopathies (ASRIM) and Muscular Diseases (FSRMM). To help Telethon, a team of volunteers from our Lausanne office organized a fundraising lunch in our own cafeteria. With the funds that were raised, we made a donation to Telethon for medical research and social support for children. The team also participated in **Handi-Challenge** 2019 - the first public racing event for people with disabilities in Switzerland. Employees participated to support children who were taking part in the event.

International Women's Day Stream Fundraiser for Charity: Water

This year, we celebrated International Women's Day with the theme "Share Your Passion." As part of incorporating inclusive actions into work, Logitech, Logitech G, Blue Microphones and Ultimate Ears joined forces with their influencers to create a week of streams that invites streamers and employees from across the company to share their passion. In total, 9 influencers from across the globe streamed throughout the week and raised over \$50,000 USD for charity:water.

Charity:water is a non-profit organization whose goal is to bring clean and safe drinking water to developing countries. Scarcity of clean drinking water is an issue that especially impacts women, who are the primary water-gatherers in many households in developing countries. This celebration also provided an opportunity to role model inclusive gaming, which is a pillar of Logitech G's philosophy. Participating in the fun, our CEO, Bracken Darrell was challenged to "do the floss", as part of the fundraiser.

**We believe
volunteering is
much bigger than
something nice to do.
We want to make an
impact for causes in
our communities.**

Jessica Monney, Head of
Community & Advocacy



GLOBALGIVING CORONAVIRUS RELIEF FUND

DISASTER RELIEF

Across the world, in acts big and small, our employees have responded to the Covid-19 pandemic by taking action, to have a positive social impact on Healthcare, Education, and the communities that we touch.

Health Care

The Huoshenshan and Leishenshan, local authorities established two emergency field hospitals, in response to the Covid-19 outbreak. Despite lockdown conditions, our employees in China managed to acquire and donate over 60 video-enabled telemedicine carts in only four days, to enable start-up of the hospitals.

Our Design and Engineering team in Cork designed and 3D printed valves for snorkel-based ventilator masks, which were deployed at local hospitals in Cork. The team then engaged

with a government-supported task force, to figure out how to optimize the prototype design, manufacture the first 400-500 valve sets for use in other local hospitals, and engage others to print thousands more sets for hospitals across Ireland to use.

Our procurement team brought their skills to the table, by sourcing masks from across the globe, for distribution to health workers and hospitals. We distributed approximately 100,000 masks in China, Hong Kong, and Taiwan, followed by 15,000 masks in the US, Ireland, Switzerland, Italy and Netherlands, with another 100,000 planned for global distribution.

We also donated \$100K to the **GlobalGiving Coronavirus Relief Fund**. That initial donation was matched by a personal donation from our President and CEO, Bracken Darrell.

Education

We distributed thousand of webcams and headset bundles to K-12 teachers in the United States, to enable teachers to connect with students virtually and continue child education.

Communities

In Chennai, Logitech finances daily meals for employees, from the local Kadhir Dhaan /Eco kitchen. Employees chose to donate this benefit to Covid-19 health care workers, patient attendees, and staff of the Royapettah General Hospital and the Government Specialty Hospital (Omandur estate). From the initiative we were able to support 250 meals/day for these deserving people.

Ultimate Ears Pro donated \$10,000 to the MusiCares Covid-19 Relief Fund, to assist music industry artists

and professionals affected by the pandemic.

Future Plans

We are proud of the work we have done thus far but recognize that there is plenty of room to grow not only our programs but also our impact. In anticipation, we have formed up a new Community and Advocacy team, who are building our vision and strategy for our social impact and launched a **Social Impact** page on logitech.com. Starting in FY21, we have expanded our donation matching program globally, and are implementing company-sponsored Volunteer Time Off. We are also expanding our program to reflect a digital volunteering model, which will allow employees to access an even wider range of philanthropic opportunities. We look forward to continuing the work of growing our social impact programming.

In June of this year, we pledged to expand our global Volunteer Time Off program which gives all employees four days of time to devote to non-profit volunteering. We are also expanding our program to reflect a digital volunteering model, which will allow employees to access an even wider range of

philanthropic opportunities.

In addition, we are making significant Diversity and Inclusion commitments that impact multiple stakeholder groups. For example, we are making multi-year commitments to organizations that explicitly work to improve fairness and eradicate racism. Grants will be a multi-year commitment, starting with our Streamlabs' ten year, \$1,000,000 minimum commitment to address racial inequality.

We will expand our support of schools and nonprofits in under-supported communities with financial contributions, volunteering and product donations. We have partnered with Best Buy to fund and support a teen tech center for the Boys' and Girls' Club in California and will target opportunities to support other STEAM centers in underserved communities.

We have a history of investing and mentoring entrepreneurs and will look at the makeup of our investment to ensure innovation and ideas are coming from a diverse set of voices. And we are working on other long-term initiatives now to help under-represented entrepreneurs and designers. We look forward to continuing

The recent Covid-19 pandemic has shown that Logitech wants to, and is, driving change. From individuals helping neighbors with equipment to teach classes and run their businesses remotely, to our sites donating supplies, and using our sourcing strength to procure masks from around the globe. We are also donating products both in public and private.

Kirsty Russell, Head of People and Culture

ABOUT THIS REPORT

From our beginnings in a small farmhouse in Switzerland in 1981, we have grown to become a multi-brand, multi-category company that operates across all continents, to create unique experiences for consumers.

LOGITECH HSINCHU OFFICE, TAIWAN

ABOUT THIS REPORT

We share our impact in a visible way to empower our stakeholders with information. Through disclosure and transparent reporting, we build trust, accountability and credibility.

This report was prepared by our global Sustainability function, with input from key functions across Logitech and the oversight and approval of Logitech leaders. For questions or suggestions regarding this report or any aspect of our sustainability performance, please contact sustainability@logitech.com

Reporting Period

We follow an annual reporting cycle. Our last Sustainability Report was issued in August 2019 and covered Financial Year 2019, except where otherwise noted. To download or access Sustainability Reports for previous years, please visit logitech.com/sustainability.

This report was finalized in August 2020 and covers Financial Year 2020 (01 April 2019 to 31 March 2020), except where otherwise noted. In some cases, data in this report relates to the calendar year 2019 (i.e. 01 January 2019 to 31st December 2019) because stakeholders specifically requested this time-frame of reporting or we

participate in industry initiatives and wish to align with the reporting period of the initiative.

Reporting Standards

We are working towards full alignment with the following best practice reporting standards

- Consolidated set of Global Reporting Initiative (GRI) Sustainability Reporting Standards, 2020 ([link](#));
- Sustainability Accounting Standards Board (SASB) Sustainability Accounting Standard for the Technology and Communications Sector - Hardware, October 2018 ([link](#)); and
- Task-Force on Climate-Related Financial Disclosures (TCFD) Recommendations ([link](#)).

Our current GRI and SASB Content Index for this report is available from logitech.com/sustainability.

Our goal is to achieve full alignment and third-party assurance to GRI (Core Application Level) within the next three years.

Our SASB Content Index for this year's report is in the following table.

Our SASB Content Index for this year's report is available from logitech.com/sustainability. Our goal is to achieve full alignment and third-party assurance to GRI (Core Application Level) within the next three years.

For TCFD reporting, please refer to the **Climate Action** section of this report, supported by our CDP Report submission for this year, as disclosed on the Climate Action page of our website.

Corrections or Restatements of Information

None.

Contact Us

For questions or suggestions regarding this report or any aspect of our sustainability performance, please contact sustainability@logitech.com

SASB CONTENT INDEX

TOPIC	CODE	METRIC	FY20 REPORTING
Product Security	TC-HW-230a.1	Description of approach to identifying and addressing data security risks in products	Privacy and Security section
Employee Diversity & Inclusion	TC-HW-330a.1	Percentage of gender and racial/ethnic group representation for (1) management, (2) technical staff, and (3) all other employees	See Diversity and Inclusion section. Note: We are working towards full disclosure for this topic
Product Lifecycle Management	TC-HW-410a.1	Percentage of products by revenue that contain IEC62474 declarable substances	See Avoiding Targeted Substances section for an overview of how we manage products with declarable substances
	TC-HW-410a.2	Percentage of eligible products, by revenue, meeting the requirements for EPEAT® registration or equivalent	Our products are not eligible for EPEAT® registration and no equivalent exists for our product categories
	TC-HW-410a.3	Percentage of eligible products, by revenue, meeting ENERGY STAR® criteria	Our products are not eligible for Energy Star certification
	C-HW-410a.4	Weight of end-of-life products and e-waste recovered, percentage recycled	See End-of-Life section
Supply Chain Management	TC-HW-430a.1	Percentage of Tier 1 supplier facilities audited in the RBA Validated Audit Process (VAP) or equivalent, by (a) all facilities and (b) high-risk facilities	See Supplier Development section.
	TC-HW-430a.2	Tier 1 suppliers' (1) nonconformance rate with the RBA Validated Audit Process (VAP) or equivalent, and (2) associated corrective action rate for (a) priority non-conformances and (b) other nonconformances	Note: we are working towards full disclosure for this topic
Materials Sourcing	TC-HW-440a.1	Description of the management of risks associated with the use of critical materials	See Conflict Minerals section. Note: we are working towards full disclosure for this topic. In this section we describe our management program for tantalum, tungsten and cobalt, which are each defined as critical materials by the US National Research Council or other sources. See also our Logitech SEC Conflict Minerals Report We are working towards full disclosure for this topic.

DATA

CLIMATE ACTION

TABLE 1 ENERGY & ELECTRICITY CONSUMPTION

ENERGY & ELECTRICITY CONSUMPTION	UNITS	CY15	CY16	CY17	CY18	CY19
Fuel & Refrigerant Consumption						
Inhouse Manufacturing: Gas	m ₃	0	0	0	0	0
Inhouse Manufacturing: Petrol	L	21,506	18,967	12,567	12,286	11,418
Inhouse Manufacturing: Diesel	L	5,942	7,154	7,896	7,139	7,990
Inhouse Manufacturing: HCFC-22	kg	162	213	215	185	105
Inhouse Manufacturing: HFC-134a	kg	68	80	240	120	164
Offices: Natural Gas	kWh	2,438,12	2,737,125	2,919,415	3,052,978	2,308,108
Electricity Consumption						
Inhouse Manufacturing: Electricity	kWh	18,057,215	20,007,694	21,295,383	22,947,641*	21,498,069
Offices: Electricity	kWh	7,680,409	8,368,482	9,047,402	9,251,047	8,412,782

*In CY18, we captured electricity use at a third-party, non-controlled dormitory. Previously we only reported emissions from owned and controlled facilities

TABLE 2 OUR SCOPE 1 & 2 CARBON FOOTPRINT

SCOPE 1 EMISSIONS	UNITS	CY15	CY16	CY17	CY18	CY19
Inhouse Manufacturing: Natural Gas	tCO ₂ e	0	0	0	0	0
Inhouse Manufacturing: Petrol	tCO ₂ e	47	42	28	27	25
Inhouse Manufacturing: Diesel	tCO ₂ e	16	19	21	19	21
Inhouse Manufacturing: HCFC-22	tCO ₂ e	293	386	389	335	190
Inhouse Manufacturing: HFC-134a	tCO ₂ e	97	114	343	172	235
Offices: Natural Gas	tCO ₂ e	498	560	597	562	424
Total Scope 1	tCO ₂ e	952	1,120	1,377	1,114	895
SCOPE 2 EMISSIONS	UNITS	CY15	CY16	CY17	CY18	CY19
Inhouse Manufacturing: Market-Based	tCO ₂ e	12,652	12,636	12,419	0	0
Offices: Market-Based	tCO ₂ e	3,473	3,558	3,874	4,242	1,954
Total Scope 2 (Market-Based)	tCO ₂ e	16,125	16,194	16,293	4,242	1,954
SCOPE 1 & 2 EMISSIONS	UNITS	CY15	CY16	CY17	CY18	CY19
Total	tCO ₂ e	17,077	17,314	17,671	5,355	2,848

TABLE 3 CARBON REDUCTION PROJECTS AT OUR PRODUCTION FACILITY

PROJECT TYPE	PROJECT SUBTYPE	ESTIMATED ANNUAL ENERGY SAVING (KWH)
Energy efficiency: Building services	Lighting (switch to LED lighting)-LED percentage in the factory increased from 77% to 99.5% in 2019	325,000
Energy efficiency: Processes	Changing air compressors	36,000
Energy efficiency: Building services	Building controls- Install time controllers for drinking water fountains, stairwell and public area lighting	35,000
Total Savings (kWh)		396,000
Total Saving (tCO₂e)		248

GRAPH A: GLOBAL UPTAKE OF RENEWABLE ELECTRICITY

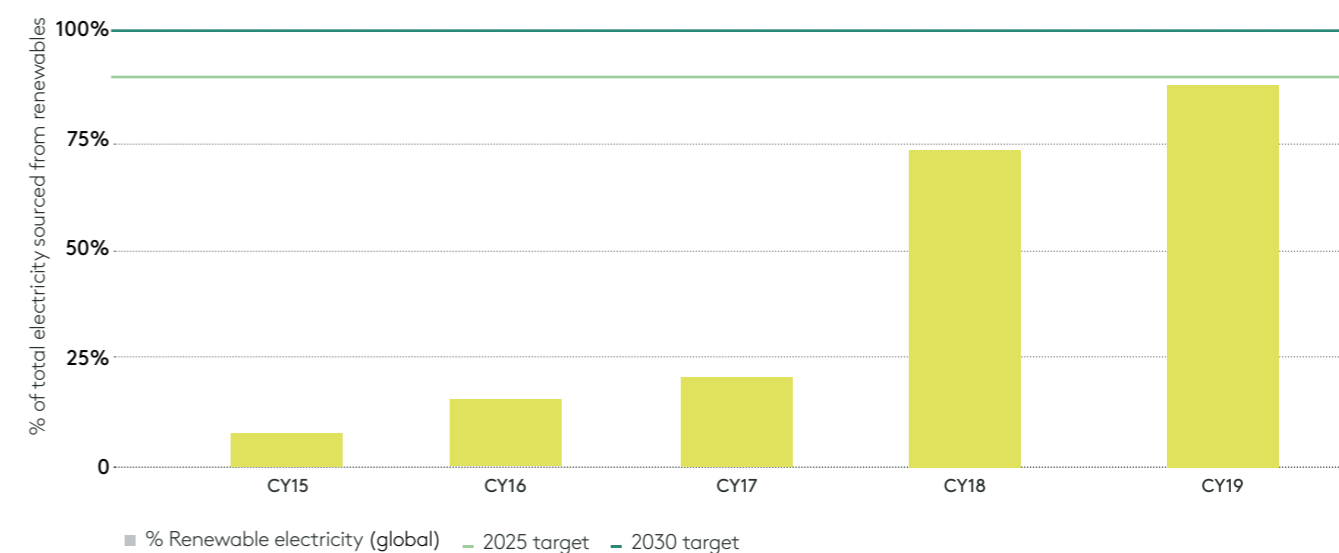

TABLE 5 ENVIRONMENTAL INSTRUMENTS

	UNITS	CY15	CY16	CY17	CY18	CY19
Inhouse Manufacturing: Renewable Electricity	tCO ₂ e	0	3,127	4,820	15,168	13,473
Offices: Renewable Electricity	tCO ₂ e	0	30	22	101	1,297
Carbon Avoidance Offsets	tCO ₂ e	0	0	0	2,218	1,070
Carbon Sequestration Offsets	tCO ₂ e	0	0	0	0	895

Data

continued

TABLE 6 SUMMARY FOR SCOPE 1 & 2

	UNITS	CY15	CY16	CY17	CY18	CY19
Gross Scope 1+2 Footprint (before instruments)	tCO ₂ e	18,652	20,471	22,512	20,624	17,618
Environmental Instruments for Scope 1+2 (excl. offsets)	tCO ₂ e	0	3,157	4,841	15,269	14,770
Net Scope 1+2 Footprint (after instruments, excl. offsets)	tCO ₂ e	17,077	17,314	17,671	5,355	2,848
Carbon intensity*	tCO ₂ e/ Million USD	12.31	11.16	10.57	2.85	1.45

* Carbon intensity is calculated as total Scope 1 & 2 emissions from our production facility and offices, divided by the revenue from our own operations (i.e. excluding revenue from JDM and Contract Manufacturing)

TABLE 7 SCOPE 3 INVENTORY FOR CY19

GREENHOUSE GAS PROTOCOL CATEGORY	APPLICABLE	MATERIAL	ESTIMATED CARBON FOOTPRINT (TCO ₂ E)	% OF TOTAL ESTIMATED CORPORATE CARBON FOOTPRINT
Category 1: Purchased goods and services	Yes	Yes	772,830	73%
Category 2: Capital Goods	Yes	No	20,149	2%
Category 3: Fuel- & Energy-Related Activities Not Included in Scope 1 or 2	Yes	No	4,738	0%
Category 4: Upstream transportation and distribution	Yes	Yes	47,375	4%
Category 5: Waste generated in operations	Yes	No	35	0%
Category 6: Business Travel	Yes	No	6,167	1%
Category 7: Employee Commuting	Yes	No	12,480	1%
Category 8: Upstream leased assets	No	No	0	0%
Category 9: Downstream transportation and distribution	Yes	No	12,440	1%
Category 10: Processing of sold products	No	No	0	0%
Category 11: Use of sold products	Yes	Yes	115,815	11%
Category 12: End of Life treatment of sold products	Yes	Yes	58,952	6%
Category 13: Downstream leased assets	No	No	0	0%
Category 14: Franchises	No	No	0	0%
Category 15: Investments	No	No	0	0%

■ Not material

TABLE 8 EMISSION FACTORS

YEAR	SOURCE
CY19	<ul style="list-style-type: none"> UK DEFRA: From Department for Business, Energy & Industrial Strategy 2019 IEA 2018, International Energy Agency emission factors EPA 2018, Emission Factors for Greenhouse Gas Inventories For LCA/PCF Studies: GaBi SP 39 and ecoinvent v3.5 databases with impact assessment method IPCC AR5 GWP100, incl biogenic carbon, incl. land use change Sphera, 2020. GaBi LCA Databases (Service Pack 39). Available online: http://www.gabi-software.com/international/databases/gabi-databases/ (accessed on 07 August 2020) Ecoinvent, 2020. Ecoinvent LCA Database (ecoinvent version 3.6). Available online: https://www.ecoinvent.org/database/database.html (accessed on 07 August 2020) ifu Hamburg, 2020. Umberto LCA + (version 10). Available online: https://www.ifu.com/en/umberto/lca-software/ (accessed on 07 August 2020) The Global Logistics Emissions Council Framework for Logistics Emissions Accounting and Reporting Version 2.0 ("the GLEC Framework")
CY18	<ul style="list-style-type: none"> UK DEFRA: From Department for Business, Energy & Industrial Strategy 2018 IEA 2018, International Energy Agency emission factors EPA, Emission Factors for Greenhouse Gas Inventories
CY17	<ul style="list-style-type: none"> The Baseline Emission Factors for Regional Power Grids in China in 2015 published by The Department of Climate Change of the National Development and Reform Commission (NDRC) in 2016 UK DEFRA: From Department for Business, Energy & Industrial Strategy 2017 IEA 2015, International Energy Agency emission factors EPA 2014, Emission Factors for Greenhouse Gas Inventories
CY10 - CY16	<ul style="list-style-type: none"> GHG Protocol - International Energy Agency (Data Services - 2007 Edition) UK DEFRA: From Department for Business, Energy & Industrial Strategy 2016 IEA 2010, International Energy Agency emission factors EPA 2010, Emission Factors for Greenhouse Gas Inventories IPCC (default based on NCV) 2006

DESIGN FOR SUSTAINABILITY (DFS)

METRIC	UNITS	CY19
Major Product Lines*, for which we have a Full or Screening LCA	%	24
Major Product Lines*, which are certified CarbonNeutral [®] , manufactured with post-consumer recycled plastic, or incorporating FSC-certified packaging	%	18
Major Product Lines*, which are eco-labelled (certified CarbonNeutral [®]) or incorporating FSC-certified packaging	%	17

* Major Product Lines: Product Lines accounting for more than 80% of shipments, by units, in CY19

Data

continued

RESPONSIBLE MANUFACTURING

WATER CONSUMPTION

METRIC	UNITS	CY15	CY16	CY17	CY18	CY19
Inhouse Manufacturing: Cold Water	tons	250,645	247,752	256,738	313,948	326,482
Inhouse Manufacturing: Hot Water	tons	15,720	12,297	12,232	17,240	18,632
Offices: Cold Water*	tons	31,331	30,969	32,092	39,244	40,810
Total	tons	281,976	278,721	288,830	353,192	367,292

* Extrapolated from factory data, taking into account differences in daily activities and headcount

WASTE

WASTE CATEGORY	UNITS	TREATMENT	CY17	CY18	CY19
In-house Manufacturing					
Food waste	tons	Recycled	1,306.35	750.00	555.30
Paper Packaging	tons	Recycled	112.40	358.66	389.02
Wood Packaging	tons	Recycled	168.10	95.86	80.50
Plastic Packaging	tons	Recycled	10.89	31.80	34.51
Defect Product	tons	Recycled	N/R	N/R	4.24
LED Lamps	tons	Incinerated (with energy recovery)	N/R	N/R	0.3
Printed Circuit Board	tons	Recycled	80.80	100.05	104.30
Waste Oil	tons	Incinerated (with energy recovery)	0.00	0.00	0.10
Chemical bottles & wiping clothes	tons	Incinerated (with energy recovery)	1.94	4.03	3.22
Alcohol	tons	Incinerated (with energy recovery)	0.93	0.95	0.80
Lamps	tons	Recycled	0.21	0.15	0.14
Offices					
Mixed waste*	tons		21.0	26.0	27.0
Total	tons		1,703	1,368	1,200

N/R = Not Reported. Data was not available at the time of reporting

* Extrapolated from factory data, taking into account differences in daily activities and headcount

AIR EMISSIONS FROM OUR PRODUCTION FACILITY

AIR EMISSION CATEGORY	UNITS	CY17	CY18	CY19
Sulfur Dioxide	tons	0	0	0
HFCs to Air	tons	0.240	0.120	0.164
Carbon Dioxide to Air	tons	0	0	0
Dinitrogen Oxide (Nitrous Oxide)	tons	0	0	0
Methane to Air	tons	0	0	0
Particulates to Air	tons	0	0	0
VOCs to Air	tons	0	0	0
Perfluorocarbons	tons	0	0	0

Note: Air emissions from our operations are subthreshold of any license requirements. Our activities are limited to assembly and testing.

Note: Emissions from mobile equipment (one forklift, one truck and five company vehicles are not considered), as well as emissions from an emergency diesel generator. These emissions are not reported because the use of the vehicles and generator was immaterial during the reporting period.

HEALTH & SAFETY

METRIC*	UNITS	WORKER CATEGORY	CY18	CY19
Number of fatalities, due to work-related injury	# cases	Employees	0	0
		Non-Employee Workers**	0	0
Number of fatalities, due to work-related ill-health	# cases	Employees	0	0
		Non-Employee Workers	0	0
Number of high-consequence work-related injuries	# cases	Employees	0	0
		Non-Employee Workers	0	0
Number of recordable work-related injuries***	# cases	Employees	5	4
		Non-Employee Workers	0	0
Number of recordable work-related ill health	# cases	Employees	0	0
		Non-Employee Workers	0	0
Total hours of Health & Safety training provided	# hours	Employees	248,592	221,136
		Non-Employee Workers	688	764
% of workers covered by the H&S Management System		Employees	100%	100%

*The scope and boundaries of metrics aligns with OSHA requirements and SASB good practice

** Non-Employee Workers: Workers who do not have a direct employment contract with Logitech but their routine work and/or workplace is controlled by Logitech

*** Incident categories comprised hit/cut, due to manual handling of materials, equipment or tools.

Data

continued

END-OF-LIFE RECYCLING

FINANCED RECYCLING (TONS) SINCE 2010

	CY10	CY11	CY12	CY13	CY14	CY15	CY16	CY17	CY18	CY19	Cumulative (Since CY10)
Electrical devices (t)	5,173	2,815	2,485	1,948	2,310	2,275	3,782	3,319	3,355	3,531	30,992
Batteries (t)	171	113	177	189	211	287	427	409	394	419	2,797
Packaging (t)	2,216	1,872	1,381	1,213	1,146	1,207	2,095	2,070	1,900	1,893	16,993
Total (t)	7,560	4,800	4,044	3,349	3,667	3,769	6,303	5,798	5,650	5,843	50,782



logitech[®]
SUSTAINABILITY
REPORT FY20